



Test Report issued under the responsibility of:

SGS Fimko Ltd.

TEST REPORT IEC 60335-2-14 Household and similar electrical appliances – Safety – Part 2-14: Particular requirements for kitchen machines	
Report Number.....	GZES170701270401
Date of issue.....	2017-10-13
Total number of pages	113
Name of Testing Laboratory preparing the Report	SGS-CSTC Standards Technical Services Co., Ltd. Shunde Branch
Applicant's name	Jiangmen Bestone Electric Technology Co., Ltd.
Address.....	Sanyawei, Muzhou Village, Muzhou Town, Xinhui, Jiangmen, Guangdong, China
Test specification:	
Standard	IEC 60335-2-14:2016 used in conjunction with IEC 60335-1:2010, COR1:2010, COR2:2011, AMD1:2013
Test procedure	CB Scheme
Non-standard test method	N/A
Test Report Form No.	IEC60335_2_14P
Test Report Form(s) Originator	Intertek Semko AB
Master TRF	Dated 2017-02
Copyright © 2017 IEC System of Conformity Assessment Schemes for Electrotechnical Equipment and Components (IECEE System). All rights reserved.	
This publication may be reproduced in whole or in part for non-commercial purposes as long as the IECEE is acknowledged as copyright owner and source of the material. IECEE takes no responsibility for and will not assume liability for damages resulting from the reader's interpretation of the reproduced material due to its placement and context.	
If this Test Report Form is used by non-IECEE members, the IECEE/IEC logo and the reference to the CB Scheme procedure shall be removed.	
This report is not valid as a CB Test Report unless signed by an approved CB Testing Laboratory and appended to a CB Test Certificate issued by an NCB in accordance with IECEE 02.	
General disclaimer:	
The test results presented in this report relate only to the object tested. This report shall not be reproduced, except in full, without the written approval of the Issuing CB Testing Laboratory. The authenticity of this Test Report and its contents can be verified by contacting the NCB, responsible for this Test Report.	

Test item description :	Blender
Trade Mark :	—
Manufacturer	Same as applicant
Model/Type reference	BT-B02A, BT-B02B, BT-B05A, BT-B05B, BT-B12A, BT-B12B, BT-B15A, BT-B15B, BT-B22A, BT-B22B, BT-B25A, BT-B25B, BT-B32A, BT-B32B, BT-B35A, BT-B35B
Ratings	220 V – 240 V; 50 Hz / 60 Hz; 500 W; Class II

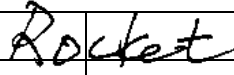
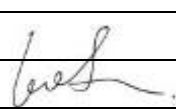
Responsible Testing Laboratory (as applicable), testing procedure and testing location(s):	
<input checked="" type="checkbox"/> CB Testing Laboratory:	SGS-CSTC Standards Technical Services Co., Ltd. Shunde Branch
Testing location/ address.....:	Building 1, European Industrial Park, No.1, Shunhe South Road, Wusha, Daliang, Shunde District, Foshan, Guangdong, China
Tested by (name, function, signature).....:	Rocket He 
Approved by (name, function, signature)....:	Leo Huang 
<input type="checkbox"/> Testing procedure: CTF Stage 1:	
Testing location/ address.....:	
Tested by (name, function, signature).....:	
Approved by (name, function, signature)....:	
<input type="checkbox"/> Testing procedure: CTF Stage 2:	
Testing location/ address.....:	
Tested by (name + signature).....:	
Witnessed by (name, function, signature) .:	
Approved by (name, function, signature)....:	
<input type="checkbox"/> Testing procedure: CTF Stage 3:	
<input type="checkbox"/> Testing procedure: CTF Stage 4:	
Testing location/ address.....:	
Tested by (name, function, signature).....:	
Witnessed by (name, function, signature) .:	
Approved by (name, function, signature)....:	
Supervised by (name, function, signature) :	

<p>List of Attachments (including a total number of pages in each attachment):</p> <p>Attachment 1 including 7 pages of IEC 60335-1_A2-2016 Attachment 2 including 17 pages of eu_gd_iec60335_2_14P Attachment 3 including 4 pages of EN 60335-2-14_A12 2016 Attachment 4 including 3 pages of Circuit diagram Attachment 5 including 71 pages of photo document</p>	
<p>Summary of testing:</p>	
<p>Tests performed (name of test and test clause):</p> <p>Tests according to the following standards were carried out: IEC 60335-2-14: 2016 IEC 60335-1: 2010 + A1: 2013 + A2: 2016</p> <p>After review, model I BT-B25B was subjected to the full test. Model BT-B15A, BT-B35B, BT-B32A were subjected to the clause 10, 11, 13, 15, 16 and construction check. All the other models were subjected to the construction check</p> <p>The submitted samples complied with the above requirements.</p>	<p>Testing location:</p> <p>SGS-CSTC Standards Technical Services Co., Ltd. Shunde Branch Building 1, European Industrial Park, No.1, Shunhe South Road, Wusha, Daliang, Shunde District, Foshan, Guangdong, China.</p>
<p>Summary of compliance with National Differences (List of countries addressed):</p> <p>EU Group Differences</p> <p>The product fulfils the requirements of: EN 60335-2-14: 2006 + A1: 2008 + A11: 2012 + A12: 2016 EN 60335-1: 2012 + A11: 2014 EN 62233: 2008</p>	

Copy of marking plate:

The artwork below may be only a draft. The use of certification marks on a product must be authorized by the respective NCBs that own these marks.



Remark: Marking plate for other models are same as above except the model name.

Remark: other labels were identical with above except for the model name.

1. As declared by the applicant, the importer (and manufacturer, if it is different)'s name, registered trade name or registered trade mark and the postal address will be marked on the products before being place on the market. The contact details shall be in a language easily understood by end-users and market surveillance authorities.

2. Marking on the packaging or in a document accompanying the electrical equipment is only acceptable if it is not possible to place such markings on the product.

3. The Height of CE logo shall not be less than 5 mm; Height of WEEE logo shall not be less than 7 mm

Test item particulars:	
Classification of installation and use: Portable appliance for household and indoor use	
Supply Connection: Non-detachable power cord fitted with plug:	
Possible test case verdicts:	
- test case does not apply to the test object..... : N/A	
- test object does meet the requirement..... : P (Pass)	
- test object does not meet the requirement..... : F (Fail)	
Testing:	
Date of receipt of test item : 2017-07-31	
Date (s) of performance of tests : 2017-07-31 to 2017-09-15	
General remarks:	
<p>"(See Enclosure #)" refers to additional information appended to the report. "(See appended table)" refers to a table appended to the report.</p> <p>Throughout this report a <input checked="" type="checkbox"/> comma / <input type="checkbox"/> point is used as the decimal separator. This document is issued by the Company subject to its General Conditions of Service, available on request or accessible at http://www.sgs.com/en/Terms-and-Conditions.aspx and, for electronic format documents, subject to Terms and Conditions for Electronic Documents at http://www.sgs.com/en/Terms-and-Conditions/Terms-e-Document.aspx. Attention is drawn to the limitation of liability, indemnification and jurisdiction issues defined therein.</p> <p>Any holder of this document is advised that information contained hereon reflects the Company's findings at the time of its intervention only and within the limits of Client's instructions, if any. The Company's sole responsibility is to its Client and this document does not exonerate parties to a transaction from exercising all their rights and obligations under the transaction documents. This document cannot be reproduced except in full, without prior written approval of the Company. Any unauthorized alteration, forgery or falsification of the content or appearance of this document is unlawful and offenders may be prosecuted to the fullest extent of the law.</p> <p>Unless otherwise stated the results shown in this test report refer only to the sample(s) tested and such sample(s) are retained for 3 months only.</p>	
Manufacturer's Declaration per sub-clause 4.2.5 of IEC60335-2-14:	
The application for obtaining a CB Test Certificate includes more than one factory location and a declaration from the Manufacturer stating that the sample(s) submitted for evaluation is (are) representative of the products from each factory has been provided :	<input type="checkbox"/> Yes <input checked="" type="checkbox"/> Not applicable
When differences exist; they shall be identified in the General product information section.	
Name and address of factory (ies) : Same as applicant	

General product information:

Blender for household and indoor use only.

Appliance was with two functions: blender and coffee mill.







All models were identical except the switch type, speed, blender cup, coffee mill cup and appearance. The motor of all models was identical.

Please refer to the following table for model difference:

Table 1:

Glass (round) blender cup	Plastic (round) blender cup	Glass (triangle) blender cup	Plastic (triangle) blender cup
			

Table 2:

Model	Switch type	Speed	Blender cup	Coffee mill cup	Picture of the stand	Remark		
BT-B02A	CJ-102	2	Glass (round)			They were identical except the switch type, speed and blender cup.		
BT-B02B		2	Plastic (round)					
BT-B05A	MFR01	5	Glass (round)					
BT-B05B		5	Plastic (round)					
BT-B12A	CJ-102	2	Glass (round)				They were identical except the switch type, speed and blender cup.	
BT-B12B		2	Plastic (round)					
BT-B15A	MFR01	5	Glass (round)					
BT-B15B		5	Plastic (round)					
BT-B22A	CJ-102	2	Glass (round)					
BT-B22B		2	Plastic (round)					

BT-B25A	MFR0 1	5	Glass (round)			
BT-B25B		5	Plastic (round)			
BT-B32A	CJ- 102	2	Glass (triangle)			They were identical except the switch type, speed, colour and blender cup.
BT-B32B		2	Plastic (triangle)			
BT-B35A	MFR0 1	5	Glass (triangle)			
BT-B35B		5	Plastic (triangle)			

IEC 60335-2-14			
Clause	Requirement + Test	Result - Remark	Verdict
5	GENERAL CONDITIONS FOR THE TESTS		--
	Tests performed according to clause 5, e.g. nature of supply, sequence of testing, etc.		P
5.2	Addition: Three additional coffee mills and grain grinders are required for the test of 19.102. The additional test of 25.14 is carried out on a separate appliance. (IEC 60335-2-14 ed. 6)		P
6	CLASSIFICATION		--
6.1	Class II or class III for hand-held kitchen machines. (IEC 60335-2-14)		N/A
	Class 0 or class I if their rated voltage does not exceed 150 V. (IEC 60335-2-14)		N/A
6.2	Protection against harmful ingress of water	IPX0	N/A
7	MARKING AND INSTRUCTIONS		--
7.1	Rated voltage or voltage range (V)..... :	220 V – 240 V	P
	Symbol for nature of supply, or..... :		N/A
	Rated frequency (Hz)..... :	50 Hz / 60 Hz	P
	Rated power input is marked. (IEC 60335-2-14)	500 W	P
	Rated current (A)		N/A
	Manufacturer's or responsible vendor's name, trademark or identification mark	Jiangmen Bestone Electric Technology Co., Ltd.	P
	Model or type reference	BT-B02A, BT-B02B, BT-B05A, BT-B05B, BT-B12A, BT-B12B, BT-B15A, BT-B15B, BT-B22A, BT-B22B, BT-B25A, BT-B25B, BT-B32A, BT-B32B, BT-B35A, BT-B35B	P
	Symbol IEC 60417-5172, for class II appliances		P
	IP number, other than IPX0	IPX0	N/A
	Symbol IEC 60417-5180, for class III appliances, unless		N/A
	the appliance is operated by batteries only		N/A
	Symbol IEC 60417-5018, for class II and class III appliances incorporating a functional earth (IEC 60335-1/A1:2013)		N/A
	Symbol IEC 60417-5036, for the enclosure of electrically-operated water valves in external hose-sets for connection of an appliance to the water mains, if the working voltage exceeds extra-low voltage		N/A

IEC 60335-2-14			
Clause	Requirement + Test	Result - Remark	Verdict
	Stands provided with cordless blenders are marked with: (IEC 60335-2-14)		N/A
	- the name, trademark or identification mark of the manufacturer or responsible vendor		N/A
	- the model or type reference		N/A
7.2	Warning for stationary appliances for multiple supply		N/A
	Warning placed in vicinity of terminal cover		N/A
7.3	Range of rated values marked with the lower and upper limits separated by a hyphen	220 V – 240 V	P
	Different rated values marked with the values separated by an oblique stroke		N/A
7.4	Appliances adjustable for different rated voltages or rated frequencies, the voltage or the frequency setting is clearly discernible (IEC 60335-1/A1:2013)		N/A
	Requirement met if frequent changes are not required and the rated voltage or rated frequency to which the appliance is to be adjusted is determined from a wiring diagram (IEC 60335-1/A1:2013)		N/A
7.5	Appliances with more than one rated voltage or one or more rated voltage ranges, marked with rated input or rated current for each rated voltage or range, unless		N/A
	the power input is related to the arithmetic mean value of the rated voltage range		P
	Relation between marking for upper and lower limits of rated power input or rated current and voltage is clear		N/A
7.6	Correct symbols used		P
	Symbol for nature of supply placed next to rated voltage		N/A
	Symbol for class II appliances placed unlikely to be confused with other marking		P
	Units of physical quantities and their symbols according to international standardized system		P
7.7	Connection diagram fixed to appliances to be connected to more than two supply conductors and appliances for multiple supply, unless		N/A
	correct mode of connection is obvious		N/A
7.8	Except for type Z attachment, terminals for connection to the supply mains indicated as follows:		--
	- marking of terminals exclusively for the neutral conductor (letter N)		N/A

IEC 60335-2-14			
Clause	Requirement + Test	Result - Remark	Verdict
	- marking of protective earthing terminals (symbol IEC 60417-5019)		N/A
	- marking of functional earthing terminals (symbol IEC 60417-5018) (IEC 60335-1/A1:2013)		N/A
	- marking not placed on removable parts		N/A
7.9	Marking or placing of switches which may cause a hazard		P
7.10	Indications of switches on stationary appliances and controls on all appliances by use of figures, letters or other visual means.....:	(See photo document)	P
	This applies also to switches which are part of a control		P
	If figures are used, the off position indicated by the figure 0		P
	The figure 0 indicates only OFF position, unless no confusion with the OFF position		P
7.11	Indication for direction of adjustment of controls		P
7.12	Instructions for safe use provided		P
	Details concerning precautions during user maintenance		P
	The instructions state that:		--
	- the appliance is not to be used by persons (including children) with reduced physical, sensory or mental capabilities, or lack of experience and knowledge, unless they have been given supervision or instruction		P
	- children being supervised not to play with the appliance		P
	For a part of class III construction supplied from a detachable power supply unit, the instructions state that the appliance is only to be used with the unit provided		N/A
	Instructions for class III appliances state that it must only be supplied at SELV, unless		N/A
	it is a battery-operated appliance, the battery being charged outside the appliance		N/A
	For appliances for altitudes exceeding 2000 m, the maximum altitude is stated (IEC 60335-1/A1:2013).....:		N/A
	The instructions for appliances incorporating a functional earth states that the appliance incorporates an earth connection for functional purposes only (IEC 60335-1/A1:2013)		N/A

IEC 60335-2-14			
Clause	Requirement + Test	Result - Remark	Verdict
	Instructions include the operating times for accessories (IEC 60335-2-14)		P
	Accessories, other than those supplied with the appliance, include instructions for their safe use. (IEC 60335-2-14)		N/A
	Adequate instruction for use for slicing machines provided with a base having a plain surface underneath the sliding feed table (IEC 60335-2-14)		N/A
	The instructions for food processors and blenders warn against misuse (IEC 60335-2-14)		P
	Be careful when handling the sharp cutting blades, emptying the bowl and during cleaning (IEC 60335-2-14)		P
	Be careful if hot liquid is poured into the food processor or blender as it can be ejected out of the appliance due to a sudden steaming (IEC 60335-2-14)		P
	Instructions for hand-held blenders : (IEC 60335-2-14)		—
	- always disconnect the blender from the supply if it is left unattended and before assembling, disassembling or cleaning		N/A
	- do not allow children to use the blender without supervision.		N/A
	The instructions for centrifugal juicers include the substance of the following: (IEC 60335-2-14)		—
	- Do not use the appliance if the rotating sieve or the protecting cover is damaged or has visible cracks. (IEC 60335-2-14)		N/A
	The instructions for cordless blenders state that the blender is only to be used with the stand provided. (IEC 60335-2-14)		N/A
	The blender and stand of the cordless blender can be lifted together by gripping the handle of the blender, the instructions include the substance of the following: (IEC 60335-2-14)		—
	CAUTION: Ensure that the blender is switched off before removing it from the stand.		N/A
	The instructions include details on how to clean surfaces in contact with food (IEC 60335-2-14)		P
	The instructions for appliances incorporating a switch necessary for compliance with 22.40 include the substance of the following: (IEC 60335-2-14)		—

IEC 60335-2-14			
Clause	Requirement + Test	Result - Remark	Verdict
	Switch off the appliance and disconnect from supply before changing accessories or approaching parts that move in use		P
	Instructions for noodle makers shall include (IEC60335-2-14 Ed.6)		N/A
	- the maximum quantity of ingredients		N/A
	- appliance intended to be used in household and similar applications as specified		N/A
	Limitations of use shall be stated in the instructions (IEC60335-2-14 Ed.6)	Household use only	P
7.12.1	Sufficient details for installation supplied		P
	For an appliance intended to be permanently connected to the water mains and not connected by a hose-set, this is stated		N/A
	If different rated voltages or different rated frequencies are marked, the instructions state what action to be taken to adjust the appliance (IEC 60335-1/A1:2013)		N/A
7.12.2	Stationary appliances not fitted with means for disconnection from the supply mains having a contact separation in all poles that provide full disconnection under overvoltage category III, the instructions state that means for disconnection must be incorporated in the fixed wiring in accordance with the wiring rules		N/A
7.12.3	Insulation of the fixed wiring in contact with parts exceeding 50 K during clause 11; instructions state that the fixed wiring must be protected		N/A
7.12.4	Instructions for built-in appliances:		--
	- dimensions of space		N/A
	- dimensions and position of supporting and fixing		N/A
	- minimum distances between parts and surrounding structure		N/A
	- minimum dimensions of ventilating openings and arrangement		N/A
	- connection to supply mains and interconnection of separate components		N/A
	- allow disconnection of the appliance after installation, by accessible plug or a switch in the fixed wiring, unless		N/A
	a switch complying with 24.3		N/A
7.12.5	Replacement cord instructions, type X attachment with a specially prepared cord		N/A

IEC 60335-2-14			
Clause	Requirement + Test	Result - Remark	Verdict
	Replacement cord instructions, type Y attachment		P
	Replacement cord instructions, type Z attachment		N/A
7.12.6	Caution in the instructions for appliances incorporating a non-self-resetting thermal cut-out that is reset by disconnection of the supply mains, if this cut-out is required to comply with the standard		N/A
7.12.7	Instructions for fixed appliances stating how the appliance is to be fixed		N/A
7.12.8	Instructions for appliances connected to the water mains:		--
	- max. inlet water pressure (Pa)..... :		N/A
	- min. inlet water pressure, if necessary (Pa :		N/A
	Instructions concerning new and old hose-sets for appliances connected to the water mains by detachable hose-sets		N/A
7.13	Instructions and other texts in an official language	English	P
7.14	Marking clearly legible and durable, rubbing test as specified		P
7.15	Markings on a main part		P
	Marking clearly discernible from the outside, if necessary after removal of a cover		P
	For portable appliances, cover can be removed or opened without a tool		N/A
	For stationary appliances, name, trademark or identification mark and model or type reference visible after installation		N/A
	For fixed appliances, name, trademark or identification mark and model or type reference visible after installation according to the instructions		N/A
	Indications for switches and controls placed on or near the components. Marking not on parts which can be positioned or repositioned in such a way that the marking is misleading		P
	The symbol IEC 60417-5018 placed next to the symbol IEC 60417-5172 or IEC 60417-5180 (IEC 60335-1/A1:2013)		N/A
7.16	Marking of a possible replaceable thermal link or fuse link clearly visible with regard to replacing the link		N/A
8	PROTECTION AGAINST ACCESS TO LIVE PARTS		--
8.1	Adequate protection against accidental contact with live parts		P

IEC 60335-2-14			
Clause	Requirement + Test	Result - Remark	Verdict
8.1.1	Requirement applies for all positions, detachable parts removed		P
	Lamps behind a detachable cover not removed, if conditions met		N/A
	Insertion or removal of lamps, protection against contact with live parts of the lamp cap		N/A
	Use of test probe B of IEC 61032, with a force not exceeding 1 N: no contact with live parts		P
8.1.2	Use of test probe 13 of IEC 61032, with a force not exceeding 1 N, through openings in class 0 appliances and class II appliances/constructions: no contact with live parts		P
	Test probe 13 also applied through openings in earthed metal enclosures having a non-conductive coating: no contact with live parts		N/A
8.1.3	For appliances other than class II, use of test probe 41 of IEC 61032, with a force not exceeding 1 N: no contact with live parts of visible glowing heating elements		N/A
8.1.4	Accessible part not considered live if:		--
	- safety extra-low a.c. voltage: peak value not exceeding 42.4 V		N/A
	- safety extra-low d.c. voltage: not exceeding 42.4 V		N/A
	- or separated from live parts by protective impedance		N/A
	If protective impedance: d.c. current not exceeding 2 mA, and		N/A
	a.c. peak value not exceeding 0.7 mA		N/A
	- for peak values over 42.4 V up to and including 450 V, capacitance not exceeding 0,1 μ F		N/A
	- for peak values over 450 V up to and including 15 kV, discharge not exceeding 45 μ C		N/A
	- for peak values over 15kV, the energy in the discharge not exceeding 350 mJ		N/A
8.1.5	Live parts protected at least by basic insulation before installation or assembly:		--
	- built-in appliances		N/A
	- fixed appliances		N/A
	- appliances delivered in separate units		N/A

IEC 60335-2-14			
Clause	Requirement + Test	Result - Remark	Verdict
8.2	Class II appliances and constructions constructed so that there is adequate protection against accidental contact with basic insulation and metal parts separated from live parts by basic insulation only		P
	Only possible to touch parts separated from live parts by double or reinforced insulation		P
10	POWER INPUT AND CURRENT		--
10.1	Power input at normal operating temperature, rated voltage and normal operation not deviating from rated power input by more than shown in table 1 . :	(see appended table)	P
	If the power input varies throughout the operating cycle and the maximum value of the power input exceeds, by a factor greater than two, the arithmetic mean value of the power input occurring during a representative period, the power input is the maximum value that is exceeded for more than 10 % of the representative period (IEC 60335-1/A1:2013)		N/A
	Otherwise the power input is the arithmetic mean value (IEC 60335-1/A1:2013)		N/A
	Test carried out at upper and lower limits of the ranges for appliances with one or more rated voltage ranges, unless		N/A
	the rated power input is related to the arithmetic mean value		P
	A representative period is a time period of 2 min or the time specified in 11.7 for one cycle of operation, whichever is shorter. (IEC 60335-2-14)		P
	Except for noodle makers a representative period is 2min or the time specified in 11.7 (whichever is shorter) (IEC60335-2-14 Ed.6)		N/A
10.2	Current at normal operating temperature, rated voltage and normal operation not deviating from rated current by more than shown in table 2 :		N/A
	If the current varies throughout the operating cycle and the maximum value of the current exceeds, by a factor greater than two, the arithmetic mean value of the current occurring during a representative period, the current is the maximum value that is exceeded for more than 10 % of the representative period (IEC 60335-1/A1:2013)		N/A
	Otherwise the current is the arithmetic mean value (IEC 60335-1/A1:2013)		N/A

IEC 60335-2-14			
Clause	Requirement + Test	Result - Remark	Verdict
	Test carried out at upper and lower limits of the ranges for appliances with one or more rated voltage ranges, unless		N/A
	the rated current is related to the arithmetic mean value of the range		N/A
11	HEATING		--
11.1	No excessive temperatures in normal use		P
11.2	The appliance is held, placed or fixed in position as described	Place on a horizontal support	P
11.3	Temperature rises, other than of windings, determined by thermocouples		P
	Temperature rises of windings determined by resistance method, unless		P
	the windings are non-uniform or it is difficult to make the necessary connections		N/A
11.4	Heating appliances operated under normal operation at 1.15 times rated power input (W)		N/A
11.5	Motor-operated appliances operated under normal operation at most unfavourable voltage between 0.94 and 1.06 times rated voltage (V).....	1,06 x 240 V = 254,4 V	P
11.6	Combined appliances operated under normal operation at most unfavourable voltage between 0.94 and 1.06 times rated voltage (V).....		N/A
11.7	The appliance is subjected to 11.7.1, 11.7.2 and if necessary 11.7.3 (IEC60335-2-14 Ed.6)	(see appended tables)	P
11.7.1	Appliance operated for the period specified, where relevant for the number of cycles specified (11.7.101-11.7.118)		P
11.7.2	Appliance operated for the number of cycles specified (11.7.101-118) and using the maximum quantity of the load to be processed stated in the instructions, with the operating periods as follows: (IEC60335-2-14 Ed.6)		P
	- for operation periods specified in the instructions not exceeding 7min, the max. period stated +1 or 7min (whichever is less)		P
	- for operation periods specified in the instructions exceeding 7 min the max. period stated in the instructions		N/A
11.7.3	If none of the power inputs used for the tests in 11.7.1 or 11.7.2 are (IEC60335-2-14 Ed.6)		N/A
	- > 80% of rated power input for rated input <=300W		N/A

IEC 60335-2-14			
Clause	Requirement + Test	Result - Remark	Verdict
	- > rated power input - 60W for rated input between 300 and 400W		N/A
	- >85% of rated power input for rated input >400W		P
	Rated power input obtained by applying a constant torque to the appliance placed in its normal position without imbalance forces greater than in normal use. Operation with the relevant time periode(11.7.101-118)		N/A
11.7.101	Bean slicers, churns, sieving machines and slicing machines are operated for 30 min (IEC60335-2-14 Ed.6)		N/A
11.7.102	Berry juice extractors and mincers are operated for 15min (IEC60335-2-14 Ed.6)		N/A
11.7.103	Blenders that have to be kept switched on by hand and hand-held blenders are operated for 1 min with the control adjusted to the highest setting. The operation is carried out five times with rest periods of 1 min during which the mixture is replaced. (IEC60335-2-14 Ed.6)		N/A
	Other blenders, the period of operation is 3 min, the operation being carried out 10 times		P
11.7.104	Can openers are operated until the can is fully open. This operation is carried out five times with rest periods of 15 s (IEC60335-2-14 Ed.6)		N/A
11.7.105	Juicers having separate outlets for the juice and residue are operated are operated for 15min (IEC60335-2-14 Ed.6)		N/A
	Other juicers are operated for 2min.(10x with rest periods of 2min)		N/A
11.7.106	Cheese graters are operated until the cheese is grated (IEC60335-2-14 Ed.6)		N/A
11.7.107	Citrus-fruit squeezers are operated for 15 s during which two halves of fruit are squeezed. The operation is carried out 10 times with rest periods of 15 s (IEC60335-2-14 Ed.6)		N/A
11.7.108	Coffee mills having a separate container for collecting the ground coffee are operated until the container is full, unless the hopper is emptied first. This operation is carried out twice with a rest period of 1 min (IEC60335-2-14 Ed.6)		N/A
	Other coffee mills are operated until the coffee beans are completely ground or for 30 s if this is longer. The operation is carried out three times with rest periods of 1 min		P

IEC 60335-2-14			
Clause	Requirement + Test	Result - Remark	Verdict
11.7.109	Cream whippers and egg beaters are operated for 10 min with the control adjusted to the highest setting (IEC60335-2-14 Ed.6)		N/A
11.7.110	Food mixers with beaters for mixing cake batter are operated for 15 min unless they incorporate a biased-off switch, in which case they are operated for 5 min (IEC60335-2-14 Ed.6)		N/A
	Food mixers with kneaders for mixing yeast dough are operated for – 5 min for hand-held food mixers; – 10 min for other food mixers		N/A
11.7.111	Food processors are operated with the setting of the control and for the period stated in the instructions for mixing yeast dough (IEC60335-2-14 Ed.6)		N/A
	If instructions for mixing yeast dough are not provided, the food processor is operated under the most unfavourable conditions stated in the instructions.		N/A
11.7.112	Grain grinders are operated until 1 kg of wheat has been ground (IEC60335-2-14 Ed.6)		N/A
11.7.113	Ice-cream machines for use in refrigerators and freezers are operated for 5 min, after which the stirrer is stalled for 25 min.		N/A
	Other ice-cream machines are operated for 30 min		N/A
11.7.114	Knife sharpeners are operated for 10 min (IEC60335-2-14 Ed.6)		N/A
11.7.115	Knives are operated for 15 min (IEC60335-2-14 Ed.6)		N/A
11.7.116	Potato peelers of the container type are operated until the potatoes are adequately peeled. Potatoes may be peeled in more than one batch. Peeling periods are separated by rest periods of 2 min (IEC60335-2-14 Ed.6)		N/A
	Hand-held potato peelers are operated for 10 min		N/A
11.7.117	Shredders and vegetable graters are operated until a batch of carrots is shredded. The operation is carried out five times with rest periods of 2 min (IEC60335-2-14 Ed.6)		N/A
11.7.118	Noodle makers: - without a mixing function operated for 15 min - with a mixing function, are operated 2 times (or sufficient number of times to process 1kg flour) whichever takes longer; rest period is 2min (IEC60335-2-14 Ed.6)		N/A

IEC 60335-2-14			
Clause	Requirement + Test	Result - Remark	Verdict
11.8	Temperature rises monitored continuously and not exceeding the values in table 3	(see appended table)	P
	For ice-cream machines for use in refrigerators and freezers, the temperature rise values are increased by 30 K. (IEC 60335-2-14)		N/A
	If the temperature rise of a motor winding exceeds the value of table 3, or		N/A
	if there is doubt with regard to classification of insulation,		N/A
	tests of Annex C are carried out		N/A
	Sealing compound does not flow out		P
	Protective devices do not operate, except		P
	components in protective electronic circuits tested for the number of cycles specified in 24.1.4		N/A
13	LEAKAGE CURRENT AND ELECTRIC STRENGTH AT OPERATING TEMPERATURE		--
13.1	Leakage current not excessive and electric strength adequate		P
	Heating appliances operated at 1.15 times the rated power input (W)		N/A
	Motor-operated appliances and combined appliances supplied at 1.06 times the rated voltage (V)	1,06 x 240 V = 254,4 V	P
	Protective impedance and radio interference filters disconnected before carrying out the tests		P
13.2	For class 0, class II and class III appliances, leakage current measured by means of the circuit described in figure 4 of IEC 60990	Class II appliances	P
	For class 0I and class I appliances, a low impedance ammeter may be used (IEC 60335-1/A1:2013)		N/A
	Leakage current measurements	(see appended table)	P
13.3	The appliance is disconnected from the supply		P
	Electric strength tests according to table 4	(see appended table)	P
	No breakdown during the tests		P
14	TRANSIENT OVERVOLTAGES		--
	Appliances withstand the transient over-voltages to which they may be subjected		N/A
	Clearances having a value less than specified in table 16 subjected to an impulse voltage test, the test voltage specified in table 6.....		N/A

IEC 60335-2-14			
Clause	Requirement + Test	Result - Remark	Verdict
	No flashover during the test, unless		N/A
	of functional insulation if the appliance complies with clause 19 with the clearance short-circuited		N/A
15	MOISTURE RESISTANCE		--
15.1	Enclosure provides the degree of moisture protection according to classification of the appliance	IPX0	P
	Compliance checked as specified in 15.1.1, taking into account 15.1.2, followed by the electric strength test of 16.3		N/A
	No trace of water on insulation which can result in a reduction of clearances or creepage distances below values specified in clause 29		N/A
15.1.1	Appliances, other than IPX0, subjected to tests as specified in IEC 60529		N/A
	Water valves containing live parts in external hoses for connection of an appliance to the water mains tested as specified for IPX7 appliances		N/A
15.1.2	Hand-held appliance turned continuously through the most unfavourable positions during the test		N/A
	Built-in appliances installed according to the instructions		N/A
	Appliances placed or used on the floor or table placed on a horizontal unperforated support		N/A
	Appliances normally fixed to a wall and appliances with pins for insertion into socket-outlets are mounted on a wooden board		N/A
	For IPX3 appliances, the base of wall mounted appliances is placed at the same level as the pivot axis of the oscillating tube		N/A
	For IPX4 appliances, the horizontal centre line of the appliance is aligned with the pivot axis of the oscillating tube, and		N/A
	for appliances normally used on the floor or table, the movement is limited to two times 90° for a period of 5 min, the support being placed at the level of the pivot axis of the oscillating tube		N/A
	Wall-mounted appliances, take into account the distance to the floor stated in the instructions		N/A
	Appliances normally fixed to a ceiling are mounted underneath a horizontal unperforated support, the pivot axis of the oscillating tube located at the level of the underside of the support, and		N/A

IEC 60335-2-14			
Clause	Requirement + Test	Result - Remark	Verdict
	for IPX4 appliances, the movement of the tube is limited to two times 90° from the vertical for a period of 5 min		N/A
	Appliances with type X attachment fitted with a flexible cord as described		N/A
	Detachable parts subjected to the relevant treatment with the main part		N/A
	However, if a part has to be removed for user maintenance and a tool is needed, this part is not removed		N/A
15.2	Spillage of liquid does not affect the electrical insulation		P
	Spillage solution comprising water containing approximately 1 % NaCl and 0,6 % rinsing agent (IEC 60335-1/A1:2013)		P
	Appliances with type X attachment fitted with a flexible cord as described		N/A
	Appliances incorporating an appliance inlet tested with or without an connector, whichever is most unfavourable		N/A
	Detachable parts are removed		P
	Appliances supplied at rated voltage and operated for 15 s with the solution still in the container: the leakage current shall not exceed the values specified in clause 13. (IEC 60335-2-14)		P
	Saline solution is then added to the liquid container until it is completely full again. A further quantity equal to 15% of the capacity of the container or 0.25 l is poured in steadily over a period of 1 min: (IEC 60335-2-14)	Max: 0,3 l	P
	Water outlets for potato peelers are blocked. (IEC 60335-2-14)		N/A
	For cordless blenders, the test is carried out on a horizontal surface with the blender both on and off its stand. (IEC 60335-2-14)		N/A
	The appliance withstands the electric strength test of 16.3		P
	No trace of water on insulation that can result in a reduction of clearances or creepage distances below values specified in clause 29		P
15.3	Appliances proof against humid conditions		P
	Checked by test Cab: Damp heat steady state in IEC 60068-2-78		P

IEC 60335-2-14			
Clause	Requirement + Test	Result - Remark	Verdict
	Detachable parts removed and subjected, if necessary, to the humidity test with the main part		P
	Humidity test for 48 h in a humidity cabinet	25 °C, 93 % R.H.	P
	Reassembly of those parts that may have been removed		P
	The appliance withstands the tests of clause 16		P
15.101	Connecting devices of stands for cordless blenders are not affected by water. (IEC 60335-2-14)		N/A
	Compliance is checked by the following test.		N/A
	The stand withstands the dielectric strength test of 16.3.		N/A
16	LEAKAGE CURRENT AND ELECTRIC STRENGTH		--
16.1	Leakage current not excessive and electric strength adequate		P
	Protective impedance disconnected from live parts before carrying out the tests		N/A
	Tests carried out at room temperature and not connected to the supply		P
16.2	Single-phase appliances: test voltage 1.06 times rated voltage (V)	1,06 x 240 V = 254,4 V	P
	Three-phase appliances: test voltage 1.06 times rated voltage divided by $\sqrt{3}$ (V)		N/A
	Leakage current measurements	(see appended table)	P
	Limit values doubled if:		--
	- all controls have an off position in all poles, or		N/A
	- the appliance has no control other than a thermal cut-out, or		N/A
	- all thermostats, temperature limiters and energy regulators do not have an off position, or		N/A
	- the appliance has radio interference filters		P
	With the radio interference filters disconnected, the leakage current do not exceed limits specified		P
16.3	Electric strength tests according to table 7	(see appended table)	--
	Test voltage applied between the supply cord and inlet bushing and cord guard and cord anchorage as specified	(see appended table)	P
	No breakdown during the tests		P
17	OVERLOAD PROTECTION OF TRANSFORMERS AND ASSOCIATED CIRCUITS		--

IEC 60335-2-14			
Clause	Requirement + Test	Result - Remark	Verdict
	No excessive temperatures in transformer or associated circuits in event of short-circuits likely to occur in normal use..... :		N/A
	Appliance supplied with 1.06 or 0.94 times rated voltage under the most unfavourable short-circuit or overload likely to occur in normal use (V)..... :		N/A
	Basic insulation is not short-circuited		N/A
	Temperature rise of insulation of the conductors of safety extra-low voltage circuits not exceeding the relevant value specified in table 3 by more than 15 K		N/A
	Temperature of the winding not exceeding the value specified in table 8		N/A
	However, limits do not apply to fail-safe transformers complying with sub-clause 15.5 of IEC 61558-1		N/A
19	ABNORMAL OPERATION		--
19.1	The risk of fire, mechanical damage or electric shock under abnormal or careless operation obviated		P
	Electronic circuits so designed and applied that a fault will not render the appliance unsafe :	(see appended table)	P
	Appliances incorporating heating elements subjected to the tests of 19.2 and 19.3, and		N/A
	if the appliance also has a control that limit the temperature during clause 11 it is subjected to the test of 19.4, and		N/A
	if applicable, to the test of 19.5		N/A
	Appliances incorporating PTC heating elements are also subjected to the test of 19.6		N/A
	Appliances incorporating motors subjected to the tests of 19.7 to 19.10, as applicable		P
	Appliances incorporating electronic circuits subjected to the tests of 19.11 and 19.12, as applicable		P
	Appliances incorporating contactors or relays subjected to the test of 19.14, being carried out before the tests of 19.11		N/A
	Appliances incorporating voltage selector switches subjected to the test of 19.15		N/A
	Unless otherwise specified, the tests are continued until a non-self-resetting thermal cut-out operates, or		N/A

IEC 60335-2-14			
Clause	Requirement + Test	Result - Remark	Verdict
	until steady conditions are established		N/A
	If a heating element or intentionally weak part becomes open-circuited, the relevant test is repeated on a second sample		P
	The test of 19.7 is only applicable to coffee mills and grain grinders that have to be kept switched on by hand, berry-juice extractors, food blenders, centrifugal juicers, churns, food mixers, food processors, ice-cream machines, mincers, and noodle makers (IEC 60335-2-14 Ed.6)	food blender	P
	Coffee mills and grain grinders subjected to the tests of 19.101, and to 19.102 unless they have to be kept switched on by hand. (IEC 60335-2-14)		P
	Noodle makers with a mixing function are also subjected to the test of 19.103 (IEC 60335-2-14 Ed.6)		N/A
19.2	Test of appliances with heating elements with restricted heat dissipation; test voltage (V), power input of 0.85 times rated power input (W)..... :		N/A
19.3	Test of 19.2 repeated; test voltage (V), power input of 1.24 times rated power input (W)..... :		N/A
19.4	Test conditions as in clause 11, any control limiting the temperature during tests of clause 11 short-circuited		N/A
19.5	Test of 19.4 repeated on Class 0I and I appliances with tubular sheathed or embedded heating elements. No short-circuiting, but one end of the element connected to the sheath		N/A
	The test repeated with reversed polarity and the other end of the heating element connected to the sheath		N/A
	The test is not carried out on appliances intended to be permanently connected to fixed wiring and on appliances where an all-pole disconnection occurs during the test of 19.4		N/A
19.6	Appliances with PTC heating elements tested at rated voltage, establishing steady conditions		N/A
	The working voltage of the PTC heating element is increased by 5% and the appliance is operated until steady conditions are re-established. The voltage is then increased in similar steps until 1.5 times working voltage or until the PTC heating element ruptures (V)..... :		N/A
19.7	Stalling test by locking the rotor if the locked rotor torque is smaller than the full load torque, or		N/A

IEC 60335-2-14			
Clause	Requirement + Test	Result - Remark	Verdict
	locking moving parts of other appliances		P
	Locked rotor, capacitors open-circuited one at a time		N/A
	Test repeated with capacitors short-circuited one at a time, unless		N/A
	capacitor is of class P2 of IEC 60252-1		N/A
	Appliances with timer or programmer supplied with rated voltage for each of the tests, for a period equal to the maximum period allowed		N/A
	An electronic timer or programmer that operates to ensure compliance with the test before the maximum period under the conditions of Clause 11 is reached, is a protective electronic circuit (IEC 60335-1/A1:2013)		N/A
	Other appliances supplied with rated voltage for a period as specified	30 s	P
	Winding temperatures not exceeding values specified in table 8	(see appended table)	P
	Coffee mills and grain grinders that have to be kept switched on by hand, berry-juice extractors, blenders for food, centrifugal juicers for fruit and vegetables, food mixers, food processors, and mincers are operated for 30 s. (IEC 60335-2-14 Ed. 6)		N/A
	Other coffee mills, grain grinders and noodle makers are tested for 5 min. (IEC 60335-2-14)		N/A
	Churns and ice-cream machines are operated until steady conditions are established. (IEC 60335-2-14)		N/A
19.8	Multi-phase motors operated at rated voltage with one phase disconnected		N/A
19.9	Running overload test on appliances incorporating motors intended to be remotely or automatically controlled or liable to be operated continuously		N/A
	Motor-operated and combined appliances for which 30.2.3 is applicable and that use overload protective devices relying on electronic circuits to protect the motor windings, are also subjected to the test		N/A
	Winding temperatures not exceeding values as specified		N/A
19.10	Series motor operated at 1.3 times rated voltage for 1 min (V)	312 V	P

IEC 60335-2-14			
Clause	Requirement + Test	Result - Remark	Verdict
	During the test, parts not being ejected from the appliance		P
	Test repeated with accessories in position but without additional load. (IEC 60335-2-14)		P
	Coffee mills and grain grinders are only tested for 30 s. (IEC 60335-2-14)		P
19.11	Electronic circuits, compliance checked by evaluation of the fault conditions specified in 19.11.2 for all circuits or parts of circuits, unless		P
	they comply with the conditions specified in 19.11.1		N/A
	Appliances incorporating an electronic circuit that relies upon a programmable component to function correctly, subjected to the test of 19.11.4.8, unless		N/A
	restarting does not result in a hazard		N/A
	Appliances having a device with an off position obtained by electronic disconnection, or a device placing the appliance in a stand-by mode, subjected to the tests of 19.11.4		N/A
	If the safety of the appliance under any of the fault conditions depends on the operation of a miniature fuse-link complying with IEC 60127, the test of 19.12 is carried out		N/A
	During and after each test the following is checked:		--
	- the temperature of the windings do not exceed the values specified in table 8		P
	- the appliance complies with the conditions specified in 19.13		P
	- any current flowing through protective impedance not exceeding the limits specified in 8.1.4		N/A
	If a conductor of a printed board becomes open-circuited, the appliance is considered to have withstood the particular test, provided both of the following conditions are met:		--
	- the base material of the printed circuit board withstands the test of Annex E		N/A
	- any loosened conductor does not reduce clearance or creepage distances between live parts and accessible metal parts below the values specified in clause 29		N/A
19.11.1	Fault conditions a) to g) in 19.11.2 are not applied to circuits or parts of circuits meeting both of the following conditions:		--
	- the electronic circuit is a low-power circuit, that is, the maximum power at low-power points does not exceed 15 W according to the tests specified		N/A

IEC 60335-2-14			
Clause	Requirement + Test	Result - Remark	Verdict
	- the protection against electric shock, fire hazard, mechanical hazard or dangerous malfunction of other parts of the appliance does not rely on the correct functioning of the electronic circuit		N/A
19.11.2	Fault conditions applied one at a time, the appliance operating under conditions specified in clause 11, but supplied at rated voltage, duration of the tests as specified:		--
	a) short circuit of functional insulation if clearances or creepage distances are less than the values specified in clause 29		N/A
	b) open circuit at the terminals of any component	C1, R1: normal operated and no hazard.	P
	c) short circuit of capacitors, unless		N/A
	they comply with IEC 60384-14		P
	d) short circuit of any two terminals of an electronic component, other than integrated circuits		N/A
	This fault condition is not applied between the two circuits of an optocoupler		N/A
	e) failure of triacs in the diode mode		N/A
	f) failure of microprocessors and integrated circuits		N/A
	g) failure of an electronic power switching device		N/A
	Each low power circuit is short-circuited by connecting the low-power point to the pole of the supply source from which the measurements were made		N/A
	Appliances having a device with an off position obtained by electronic disconnection, or a device that can place the appliance in a stand-by mode, are turned off or placed in the stand-by mode and supplied at rated voltage (IEC 60335-2-14 Ed.6)		N/A
19.11.3	If the appliance incorporates a protective electronic circuit which operates to ensure compliance with clause 19, the relevant test is repeated with a single fault simulated, as indicated in a) to g) of 19.11.2		N/A
19.11.4	Appliances having a device with an off position obtained by electronic disconnection, or		N/A
	a device that can be placed in the stand-by mode,		N/A
	subjected to the tests of 19.11.4.1 to 19.11.4.7, the device being set in the off position or in the stand-by mode		N/A

IEC 60335-2-14			
Clause	Requirement + Test	Result - Remark	Verdict
	Appliances incorporating a protective electronic circuit subjected to the tests of 19.11.4.1 to 19.11.4.7, the tests being carried out after the protective electronic circuit has operated, except that		N/A
	appliances operated for 30 s or 5 min during the test of 19.7 are not subjected to the tests for electromagnetic phenomena.		N/A
	Surge protective devices disconnected, unless		N/A
	They incorporate spark gaps		N/A
19.11.4.1	The appliance is subjected to electrostatic discharges in accordance with IEC 61000-4-2, test level 4		N/A
19.11.4.2	The appliance is subjected to radiated fields in accordance with IEC 61000-4-3, test level 3		N/A
19.11.4.3	The appliance is subjected to fast transient bursts in accordance with IEC 61000-4-4, test level 3 or 4 as specified		N/A
19.11.4.4	The power supply terminals of the appliance subjected to voltage surges in accordance with IEC 61000-4-5 (IEC 60335-1/A1:2013)		N/A
	An open circuit test voltage of 2 kV is applicable for the line-to-line coupling mode (IEC 60335-1/A1:2013)		N/A
	An open circuit test voltage of 4 kV is applicable for the line-to-earth coupling (IEC 60335-1/A1:2013)		N/A
	Earthed heating elements in class I appliances disconnected		N/A
19.11.4.5	The appliance is subjected to injected currents in accordance with IEC 61000-4-6, test level 3		N/A
19.11.4.6	Appliances having a rated current not exceeding 16 A are subjected to the Class 3 voltage dips and interruptions in accordance with IEC 61000-4-11		N/A
	Appliances having a rated current exceeding 16 A are subjected to the Class 3 voltage dips and interruptions in accordance with IEC 61000-4-34		N/A
19.11.4.7	The appliance is subjected to mains signals in accordance with IEC 61000-4-13, test level class 2		N/A
19.11.4.8	The appliance is supplied at rated voltage and operated under normal operation. After 60s the power supply is reduced to a level such that the appliance ceases to respond or parts controlled by the programmable component cease to operate		N/A
	The appliance continues to operate normally, or		N/A

IEC 60335-2-14			
Clause	Requirement + Test	Result - Remark	Verdict
	requires a manual operation to restart		N/A
19.12	If the safety of the appliance for any of the fault conditions specified in 19.11.2 depends on the operation of a miniature fuse-link complying with IEC 60127, the test is repeated, measuring the current flowing through the fuse-link; measured current (A); rated current of the fuse-link (A)		N/A
19.13	During the tests the appliance does not emit flames, molten metal, poisonous or ignitable gas in hazardous amounts		P
	Temperature rises not exceeding the values shown in table 9	(see appended table)	P
	Compliance with clause 8 not impaired		P
	If the appliance can still be operated it complies with 20.2		P
	Insulation, other than of class III appliances or class III constructions that do not contain live parts, withstands the electric strength test of 16.3, the test voltage as specified in table 4:		--
	- basic insulation (V)		N/A
	- supplementary insulation (V)		N/A
	- reinforced insulation (V).....	3000	P
	After operation or interruption of a control, clearances and creepage distances across the functional insulation withstand the electric strength test of 16.3, the test voltage being twice the working voltage		N/A
	The appliance does not undergo a dangerous malfunction, and		P
	no failure of protective electronic circuits, if the appliance is still operable		N/A
	Appliances tested with an electronic switch in the off position, or in the stand-by mode:		--
	- do not become operational, or		N/A
	- if they become operational, do not result in a dangerous malfunction during or after the tests of 19.11.4		N/A
	If the appliance contains lids or doors that are controlled by one or more interlocks, one of the interlocks may be released provided that:		--
	- the lid or door does not move automatically to an open position when the interlock is released, and		N/A
	- the appliance does not start after the cycle in which the interlock was released		N/A

IEC 60335-2-14			
Clause	Requirement + Test	Result - Remark	Verdict
	Appliances tested with an electronic switch in the off position, or in the stand-by mode: (IEC 60335-2-14)		N/A
	- not become operational, or		N/A
	- if they become operational, not result in a dangerous malfunction during or after the tests of 19.11.2		N/A
19.14	Appliances operated under the conditions of clause 11, any contactor or relay contact operating under the conditions of clause 11 being short-circuited		N/A
	For a relay or contactor with more than one contact, all contacts are short-circuited at the same time		N/A
	A relay or contactor operating only to ensure the appliance is energized for normal use is not short-circuited		N/A
	If more than one relay or contactor operates in clause 11, they are short-circuited in turn		N/A
19.15	For appliances with a mains voltage selector switch, the switch is set to the lowest rated voltage position and the highest value of rated voltage is applied		N/A
19.101	Coffee mills and grain grinders are supplied at rated voltage and operated under normal operation five times with rest periods. (IEC 60335-2-14)		P
19.102	Coffee mills and grain grinders subjected to the test as specified in IEC 60335-2-14 and carried out on three additional appliances. (IEC 60335-2-14)		P
	If any of the motors stall, original appliance subjected to the test of 19.7 for a test period of 5 min. (IEC 60335-2-14 Ed.6)		N/A
19.103	Noodle makers with a mixing function are fed with the maximum quantity of flour stated in the instruction and no water, and then operated for one operating cycle. During the test, 19.13 is applicable and the winding temperatures shall not exceed the values specified in 19.9 (IEC 60335-2-14 Ed.6)		N/A
20	STABILITY AND MECHANICAL HAZARDS		--
20.1	Appliances having adequate stability		P
	Tilting test through an angle of 10°, appliance placed on an inclined plane/horizontal support, not connected to the supply mains; appliance does not overturn		P
	Tilting test repeated on appliances with heating elements, angle of inclination increased to 15°		N/A

IEC 60335-2-14			
Clause	Requirement + Test	Result - Remark	Verdict
	Possible heating test in overturned position; temperature rise does not exceed values shown in table 9		N/A
20.2	Moving parts adequately arranged or enclosed as to provide protection against personal injury		P
	Protective enclosures, guards and similar parts are non-detachable, and		P
	have adequate mechanical strength		P
	Enclosures that can be opened by overriding an interlock are considered to be detachable parts		N/A
	Self-resetting thermal cut-outs and over current protective devices not causing a hazard, by unexpected reclosure		N/A
	Not possible to touch dangerous moving parts with the test probe described		P
	Detachable accessories are removed and covers are opened except that for : (IEC 60335-2-14)		N/A
	- centrifugal juicers, the cover and the container for collecting the residue are in position		N/A
	- graters and shredders, this is only applicable to accessories that are removed while the appliance is in operation		N/A
	Test probe not applied to: (IEC 60335-2-14)		—
	- appliances specified in the list		N/A
	– the following parts of other appliances:		--
	smooth shafts having a diameter not exceeding 8 mm, rotating at a speed not exceeding 1 500 rev/min and driven by motors having an input not exceeding 200 W		N/A
	outlet sides of grating and shredding disks rotating at a speed not exceeding 1 500 rev/min		N/A
	projections from the surface of grinding disks, cones and similar parts having a height less than 4 mm		N/A
	Test probe not applied to feed openings having a throat with following dimensions: (IEC 60335-2-14)		--
	- a height of at least 100 mm, measured from the upper edge of the cutting blade		N/A
	- an average of the maximum and minimum cross-sectional dimensions of the feed opening that does not exceed 65.5 mm		N/A

IEC 60335-2-14			
Clause	Requirement + Test	Result - Remark	Verdict
	- a maximum cross-sectional dimension of the feed opening that does not exceed 76 mm		N/A
	For blenders, detachable parts, except lids, are not removed. Test carried out with a test probe similar to that of test probe B of IEC 61032 but with circular stop face as specified. (IEC 60335-2-14)	Blender function	P
20.101	Accessories for cream whippers, egg beaters and hand-held food mixers have no knife edges, unless a suitable guard prevents accidental contact with their rotating parts (IEC 60335-2-14)		N/A
	Hand-held food mixer: not possible to release the working tools while rotating at a speed exceeding 1500 r/min (IEC 60335-2-14)		N/A
	If compliance relies on the operation of an electronic circuit the appliances is further tested as follows: (IEC 60335-2-14 Ed. 6)		—
	a) The appliance is supplied at rated voltage and operated under normal operation		N/A
	The electromagnetic phenomena tests of 19.11.4.2 and 19.11.4.5 are applied		N/A
	Beaters, kneaders and similar accessories of hand-held food mixers not be released or be capable of being released by a single action during or after, as appropriate, the electromagnetic phenomena application		N/A
	b) The appliance is supplied at rated voltage and operated under normal operation		N/A
	The fault conditions in a) to g) of 19.11.2 are applied one at a time to the electronic circuit monitoring the release mechanism		N/A
	Beaters, kneaders and similar accessories of hand-held food mixers not be released or be capable of being released by a single action during the test		N/A
	If the electronic circuit is programmable, the software contain measures to control the fault/error conditions specified in Table R.1 and is evaluated in accordance with the relevant requirements of Annex R (IEC 60335-2-14 Ed.6)		N/A
20.102	Blades of hand-held blenders are completely screened from above and are not able to touch a flat surface while rotating (IEC 60335-2-14)		N/A
	Not possible to touch the blades with the end of the test rod (diameter 8 mm) and checked by inspection		N/A

IEC 60335-2-14			
Clause	Requirement + Test	Result - Remark	Verdict
20.103	Biased-off switch of hand-held blenders other than hand-held food mixers provided with a blender attachment recessed or otherwise guarded: Test with a cylindrical rod having a diameter of 40 mm and hemispherical end: appliance does not operate. (IEC 60335-2-14 Ed. 6)		N/A
20.104	Not possible to operate the cutting blades of blenders, other than hand-held blenders, while they are accessible: test with test finger specified for blender. (IEC 60335-2-14)	Can not touch the balde by specified probe.	N/A
	With detachable parts removed, if the cutting blades of the blender can be touched with the test probe specified for blenders in 20.2, it shall not be possible to operate the appliance.		N/A
	Switches, other than biased-off switches, are placed in the on position and two simultaneous or sequential applications of test probe B of IEC 61032 are applied to biased-off switches, including interlock switches, with a force not exceeding 20 N in an attempt to operate the cutting blades.		N/A
	During the test, it shall not be possible to operate the appliance.		N/A
20.105	Centrifugal juicers (IEC 60335-2-14)		—
	- lids and covers do not open due to vibration		N/A
	- rotating parts adequately secured against becoming loose during operation		N/A
	- If speed of rotating parts >5000rev/min: lids and covers can only be closed after removal of tools		N/A
	- teeth of grating disks do not exceed 1,5mm in height		N/A
	- Ejectors on filter drums shall not project by more than 4 mm.		N/A
	- feed pusher provided, of a size that fills the throat of the hopper		N/A
	- lids and covers do not open by force test of 5N		N/A
20.106	Appliances having a feed screw or an auger shall, provide adequate protection against personal injury in normal use and shall be provided with a feed pusher. (IEC 60335-2-14, Ed. 6)		N/A
	For appliances having only one opening for inserting food and applying the feed pusher, <ul style="list-style-type: none"> - The maximum cross-sectional dimension of the opening, measured at least 100 mm from the upper edge of the feed screw or the auger shall not exceed 45 mm 		N/A

IEC 60335-2-14			
Clause	Requirement + Test	Result - Remark	Verdict
	- or the feed screw or the auger of the appliance shall not be accessible to test probe B of IEC 61032 with the feed pusher not in position.		N/A
	For appliances having different openings for inserting food and applying the feed pusher: - The maximum cross-sectional dimension of the opening for the feed pusher, (>100 mm) above feed screw or the auger shall not exceed 45 mm.		N/A
	- The feed screw or the auger of the appliance shall not be accessible to test probe B of IEC 61032 with the pusher in position and not in position.		N/A
20.107	Slicing machines, other than fixed appliances and those having a biased-off switch, incorporate means to hold the appliance in place and allow it to be released after use: no move on glass plate when subjected to test as specified. (IEC 60335-2-14, Ed. 6)		N/A
20.108	slicing machines: (IEC 60335-2-14, Ed. 6)		—
	- provided with a guard surrounding the knife and its edge		N/A
	- guard opening as small as permitted by effective use		N/A
	- edge of knife guarded as shown in Fig.101		N/A
	Knife guards shall be non-detachable unless the motor cannot be switched on after their removal.		N/A
	It shall not be possible to operate interlocks by means of test probe B of IEC 61032.		N/A
	Angle of the upper part of guard opening not exceed 75°		N/A
	The angle may be increased to 90° if the exposed part of the knife exceeding 75° is screened from above.		N/A
	Radial distance not exceed 2 mm, if the guard is flush with the plane of the knife; or		N/A
	3 mm, if the guard projects at least 0,2 mm beyond the plane of the knife.		N/A
	Distance between the outer circumference of the knife and the plate that sets the thickness of the slices shall not exceed 6 mm.		N/A
	Distance between the plate that sets the thickness of the slices and any other protecting part shall not exceed 5 mm.		N/A
	Additional guard provided if slices thicker than 15mm allowed		N/A

IEC 60335-2-14			
Clause	Requirement + Test	Result - Remark	Verdict
	Slicing machines shall incorporate a sliding feed table with a hand rest, a thumb guard and a piece holder.		N/A
	Sliding feed table adequately designed (f 30mm, d 5mm, thumb guard projects radially by at least 8mm beyond the blades)		N/A
	Piece holder enables small pieces to be sliced		N/A
	Dimensions of spikes or similar as specified		N/A
	Support of sliding table not usable for supplying food without the table in position; verified dash Nos.		N/A
20.109	Slicing machines constructed so that accidental operation of the appliance is prevented. (IEC 60335-2-14)		N/A
	Actuating member of push-button, toggle, rocker or slide switch recessed and actuated with force at least 2N.		N/A
	Actuating member of slide switch located so that unintentional actuation is unlikely and actuated with force at least 5N.		N/A
20.110	The cutting blades of bean slicers: (IEC 60335-2-14)		—
	- are at least 30 mm from the plane of the inlet opening.		N/A
	- length of the major and minor axis of the inlet and outlet openings not exceed 30 mm and 15 mm		N/A
	- dimensions of outlet openings not limited if compliance with test specified.		N/A
20.111	The rotating parts of blenders, graters and shredders:		P
	- are secured so that they are not liable to become loose during operation. (IEC 60335-2-14)		
	- a feed pusher shall be provided which fills the throat of the hopper		N/A
20.112	The cutting blade of food processors stopped within 1,5 s after the lid has been opened or removed. (IEC 60335-2-14)		N/A
20.113	The lid interlock of food processors shall be constructed so that accidental operation of the appliances is prevented (IEC 60335-2-14)		N/A
	Lid interlock switches shall be biased-off switches		N/A

IEC 60335-2-14			
Clause	Requirement + Test	Result - Remark	Verdict
	If there is an interlock between the lid and the main switch, the lid shall be locked when the switch is in the on position		N/A
	When the lid is not correctly closed , the switch shall be locked in the off position		N/A
20.114	Access to dangerous moving parts of food processors prevented for all combinations of assembly of detachable parts that allow may occur in use: comply with test as specified (IEC 60335-2-14, Ed. 6)		N/A
	Detachable parts are removed or assembled incorrectly in a manner that may occur in use, such as the incorrect location or misalignment of the parts.		N/A
	A force not exceeding 5 N is applied to the parts in any direction and it shall not be possible to touch dangerous moving parts with test probe B of IEC 61032.		N/A
20.115	Knives shall incorporate a biased-off switch that is recessed or guarded to prevent accidental operation. (IEC 60335-2-14)		N/A
	Appliance don't operate when applying a cylindrical rod with diameter 40mm to the switch		N/A
20.116	Centrifugal juicers for fruit and vegetables shall be constructed so that parts cannot become disengaged when the appliance is operated at high speed. (IEC 60335-2-14)		N/A
	Lid removed, appliance supply at rated voltage and highest speed (10 times): no part of appliance disengaged		N/A
	Lid in position, when the speed reaches its maximum value, attempt is made to remove the lid (10 times): no part of appliance disengaged		N/A
20.117	Centrifugal juicers shall withstand the stresses resulting from parts rotating at high speed (IEC 60335-2-14, Ed. 6)		N/A
	Compliance is checked by the following test that is carried out on three new appliances		N/A
	and by testing the sieve in accordance with Annex AA. (IEC 60335-2-14, Ed. 6)		N/A
	The rim of plastic material retaining the rotating sieve is cut		N/A

IEC 60335-2-14			
Clause	Requirement + Test	Result - Remark	Verdict
	If the sieve retains its structure, the rim is cut further and the test repeated until disintegration takes place		N/A
	During the test, parts shall not be ejected from the appliance.		N/A
20.118	The operation of cordless appliances incorporating cutting blades that are accessible to test probe B of IEC 61032 shall require two separate movements, unless (IEC 60335-2-14)		N/A
	The control device is not directly accessible to the probe.		N/A
20.119	Bowl and cutting blades of food blenders and hand-held blenders shall have adequate mechanical strength. (IEC 60335-2-14, Ed. 6)		P
	After the test, the bowl and cutting blades shall not be broken.		P
21	MECHANICAL STRENGTH		--
21.1	Appliance has adequate mechanical strength and is constructed as to withstand rough handling		P
	Checked by applying 3 blows to every point of the enclosure like to be weak, in accordance with test Ehb of IEC 60068-2-75, spring hammer test, with an impact energy of 0,5 J		P
	The appliance shows no damage impairing compliance with this standard, and		P
	compliance with 8.1, 15.1 and clause 29 not impaired		P
	If doubt, supplementary or reinforced insulation subjected to the electric strength test of 16.3		N/A
	If necessary, repetition of groups of three blows on a new sample		N/A
	Test also carried out on detachable parts that are necessary for protection against mechanical hazards. (IEC 60335-2-14)		P
21.2	Accessible parts of solid insulation having strength to prevent penetration by sharp implements		P
	Test not applicable if the thickness of supplementary insulation is at least 1 mm and reinforced insulation at least 2 mm	(See clause 29.3.1)	P
	The insulation is tested as specified, and does withstand the electric strength test of 16.3		N/A
22	CONSTRUCTION		--

IEC 60335-2-14			
Clause	Requirement + Test	Result - Remark	Verdict
22.1	Appliance marked with the first numeral of the IP system, relevant requirements of IEC 60529 are fulfilled		N/A
22.2	Stationary appliance: means to ensure all-pole disconnection from the supply being provided:		--
	- a supply cord fitted with a plug, or		N/A
	- a switch complying with 24.3, or		N/A
	- a statement in the instruction sheet that a disconnection incorporated in the fixed wiring is to be provided, or		N/A
	- an appliance inlet		N/A
	Singe-pole switches and single-pole protective devices for the disconnection of heating elements in single-phase, permanently connected class 01 and class I appliances, connected to the phase conductor		N/A
22.3	Appliance provided with pins: no undue strain on socket-outlets		N/A
	Applied torque not exceeding 0.25 Nm		N/A
	Pull force of 50N to each pin after the appliance has being placed in the heating cabinet; when cooled to room temperature the pins are not displaced by more than 1mm		N/A
	Each pin subjected to a torque of 0.4Nm; the pins are not rotating, unless		N/A
	rotating does not impair compliance with this standard		N/A
22.4	Appliance for heating liquids and appliance causing undue vibration not provided with pins for insertion into socket-outlets		P
22.5	No risk of electric shock when touching the pins of the plug, for appliances having a capacitor with rated capacitance equal to or greater than 0,1μF, the appliance being disconnected from the supply at the instant of voltage peak (IEC 60335-1/A1:2013)		P
	Voltage not exceeding 34 V (V) :	12 V	P
	If compliance relies on the operation of an electronic circuit, the electromagnetic phenomena tests of 19.11.4.3 and 19.11.4.4 are applied (IEC 60335-1/A1:2013)		N/A
	The discharge test is then repeated three times, voltage not exceeding 34 V (V) (IEC 60335-1/A1:2013) :		N/A

IEC 60335-2-14			
Clause	Requirement + Test	Result - Remark	Verdict
22.6	Electrical insulation not affected by condensing water or leaking liquid		P
	Electrical insulation of Class II appliances not affected if a hose ruptures or seal leaks		N/A
	In case of doubt, test as described		N/A
22.7	Adequate safeguards against the risk of excessive pressure in appliances containing liquid or gases or having steam-producing devices		N/A
22.8	Electrical connections not subject to pulling during cleaning of compartments to which access can be gained without the aid of a tool, and that are likely to be cleaned in normal use		P
22.9	Insulation, internal wiring, windings, commutators and slip rings not exposed to oil, grease or similar substances, unless		P
	the substance has adequate insulating properties		N/A
22.10	Not possible to reset voltage-maintained non-self-resetting thermal cut-outs by the operation of an automatic switching device incorporated within the appliance, if:		N/A
	- a non-self-resetting thermal cut-out is required by the standard, and		N/A
	- a voltage maintained non-self-resetting thermal cut-out is used to meet it		N/A
	Non-self-resetting thermal motor protectors have a trip-free action, unless		N/A
	they are voltage maintained		N/A
	Reset buttons of non-self-resetting controls so located or protected that accidental resetting is unlikely		N/A
22.11	Reliable fixing of non-detachable parts that provide the necessary degree of protection against electric shock, moisture or contact with moving parts		P
	Obvious locked position of snap-in devices used for fixing such parts		N/A
	No deterioration of the fixing properties of snap-in devices used in parts that are likely to be removed during installation or servicing		N/A
	Tests as described		P
22.12	Handles, knobs etc. fixed in a reliable manner		P
	Fixing in wrong position of handles, knobs etc. indicating position of switches or similar components not possible		P

IEC 60335-2-14			
Clause	Requirement + Test	Result - Remark	Verdict
	Axial force 15 N applied to parts, the shape being so that an axial pull is unlikely to be applied		N/A
	Axial force 30 N applied to parts, the shape being so that an axial pull is likely to be applied		P
22.13	Unlikely that handles, when gripped as in normal use, make the operator's hand touch parts having a temperature rise exceeding the value specified for handles which are held for short periods only		P
22.14	No ragged or sharp edges creating a hazard for the user in normal use, or during user maintenance		P
	No exposed pointed ends of self-tapping screws or other fasteners, likely to be touched by the user in normal use or during user maintenance		P
22.15	Storage hooks and the like for flexible cords smooth and well rounded		N/A
22.16	Automatic cord reels cause no undue abrasion or damage to the sheath of the flexible cord, no breakage of conductors strands and no undue wear of contacts		N/A
	Cord reel tested with 6000 operations, as specified		N/A
	Electric strength test of 16.3, voltage of 1000 V applied		N/A
22.17	Spacers not removable from the outside by hand or by means of a screwdriver or a spanner		N/A
22.18	Current-carrying parts and other metal parts resistant to corrosion		P
22.19	Driving belts not relied upon to provide the required level of insulation, unless		N/A
	constructed to prevent inappropriate replacement		N/A
22.20	Direct contact between live parts and thermal insulation effectively prevented, unless		N/A
	material used is non-corrosive, non-hygroscopic and non-combustible		N/A
22.21	Wood, cotton, silk, ordinary paper and fibrous or hygroscopic material not used as insulation, unless		N/A
	impregnated		P
	This requirement does not apply to magnesium oxide and mineral ceramic fibres used for the electrical insulation of heating elements		N/A
22.22	Appliances not containing asbestos		P
22.23	Oils containing polychlorinated biphenyl (PCB) not used		P

IEC 60335-2-14			
Clause	Requirement + Test	Result - Remark	Verdict
22.24	Bare heating elements, except in class III appliances or class III constructions that do not contain live parts, adequately supported		N/A
	In case of rupture, the heating conductor is unlikely to come in contact with accessible metal parts		N/A
22.25	Sagging heating conductors, except in class III appliances or class III constructions that do not contain live parts, cannot come into contact with accessible metal parts		N/A
22.26	For class III constructions the insulation between parts operating at safety extra-low voltage and other live parts complies with the requirements for double or reinforced insulation		N/A
22.27	Parts connected by protective impedance separated by double or reinforced insulation		N/A
22.28	Metal parts of Class II appliances conductively connected to gas pipes or in contact with water, separated from live parts by double or reinforced insulation		N/A
22.29	Class II appliances permanently connected to fixed wiring so constructed that the required degree of access to live parts is maintained after installation		N/A
22.30	Parts serving as supplementary or reinforced insulation fixed so that they cannot be removed without being seriously damaged, or		N/A
	so constructed that they cannot be replaced in an incorrect position, and so that if they are omitted, the appliance is rendered inoperable or manifestly incomplete		P
22.31	Neither clearances nor creepage distances over supplementary and reinforced insulation reduced below values specified in clause 29 as a result of wear		P
	Neither clearances nor creepage distances between live parts and accessible parts reduced below values for supplementary insulation if wires, screws etc. become loose		P
22.32	Supplementary and reinforced insulation constructed or protected against pollution so that clearances or creepage distances are not reduced below the values in clause 29		P
	Supplementary insulation of natural or synthetic rubber resistant to ageing, or arranged and dimensioned so that creepage distances are not reduced below values specified in 29.2		N/A

IEC 60335-2-14			
Clause	Requirement + Test	Result - Remark	Verdict
	Ceramic material not tightly sintered, similar materials or beads alone not used as supplementary or reinforced insulation		N/A
	Ceramic and similar porous material in which heating conductors are embedded is considered to be basic insulation, not reinforced insulation (IEC 60335-1/A1:2013)		N/A
	Oxygen bomb test at 70 °C for 96 h and 16 h at room temperature		N/A
22.33	Conductive liquids that are or may become accessible in normal use and conductive liquids that are in contact with unearthed accessible metal parts are not in direct contact with live parts, or		P
	unearthed metal parts separated from live parts by basic insulation only (IEC 60335-1/A1:2013)		N/A
	Electrodes not used for heating liquids		N/A
	For class II constructions, conductive liquids that are or may become accessible in normal use and conductive liquids that are in contact with unearthed accessible metal parts, not in direct contact with basic or reinforced insulation, unless		P
	the reinforced insulation consists of at least 3 layers		N/A
	For class II constructions, conductive liquids which are in contact with live parts, not in direct contact with reinforced insulation, unless		N/A
	the reinforced insulation consists of at least 3 layers		N/A
	An air layer not used as basic or supplementary insulation in a double insulation system if likely to be bridged by leaking liquid		P
22.34	Shafts of operating knobs, handles, levers etc. not live, unless		P
	the shaft is not accessible when the part is removed		N/A
22.35	For other than class III constructions, handles, levers and knobs, held or actuated in normal use, not becoming live in the event of a failure of basic insulation		P
	Such parts being of metal, and their shafts or fixings are likely to become live in the event of a failure of basic insulation, are either adequately covered by insulation material or their accessible parts are separated from their shafts or fixings by supplementary insulation		N/A

IEC 60335-2-14			
Clause	Requirement + Test	Result - Remark	Verdict
	This requirement does not apply to handles, levers and knobs on stationary appliances and cordless appliances, other than those of electrical components, provided they are reliably connected to an earthing terminal or earthing contact, or separated from live parts by earthed metal (IEC 60335-1/A1:2013)		N/A
	Insulating material covering metal handles, levers and knobs withstand the electric strength test of 16.3 for supplementary insulation		N/A
22.36	For appliances other than class III, handles continuously held in the hand in normal use so constructed that when gripped as in normal use, the operators hand is not likely to touch metal parts, unless		N/A
	they are separated from live parts by double or reinforced insulation		N/A
22.37	Capacitors in Class II appliances not connected to accessible metal parts and their casings, if of metal, separated from accessible metal parts by supplementary insulation, unless		P
	the capacitors comply with 22.42		N/A
22.38	Capacitors not connected between the contacts of a thermal cut-out		P
22.39	Lamp holders used only for the connection of lamps		N/A
22.40	Motor-operated appliances and combined appliances intended to be moved while in operation, or having accessible moving parts, fitted with a switch to control the motor. The actuating member of the switch being easily visible and accessible		P
	If the appliance cannot operate continuously, automatically or remotely without giving rise to a hazard, appliances for remote operation being fitted with a switch for stopping the operation. The actuating member of the switch being easily visible and accessible		N/A
22.41	No components, other than lamps, containing mercury		P
22.42	Protective impedance consisting of at least two separate components		N/A
	Values specified in 8.1.4 not exceeded if any one of the components are short-circuited or open-circuited		N/A
	Resistors checked by the test of 14.1 a) in IEC 60065		N/A

IEC 60335-2-14			
Clause	Requirement + Test	Result - Remark	Verdict
	Capacitors checked by the tests for class Y capacitors in IEC 60384-14		N/A
22.43	Appliances adjustable for different voltages, accidental changing of the setting of the voltage unlikely to occur		N/A
22.44	Appliances not having an enclosure that is shaped or decorated like a toy		P
22.45	When air is used as reinforced insulation, clearances not reduced below the values specified in 29.1.3 due to deformation as a result of an external force applied to the enclosure		P
22.46	For programmable protective electronic circuits used to ensure compliance with the standard, the software contains measures to control the fault/error conditions in table R.1		N/A
	Software that contains measures to control the fault/error conditions specified in table R.2 is to be specified in parts 2 for particular constructions or to address specific hazards		N/A
	These requirements are not applicable to software used for functional purpose or compliance with clause 11		N/A
22.47	Appliances connected to the water mains withstand the water pressure expected in normal use		N/A
	No leakage from any part, including any inlet water hose		N/A
22.48	Appliances connected to the water mains constructed to prevent backsiphonage of non-potable water		N/A
22.49	For remote operation, the duration of operation is to be set before the appliance can be started, unless		N/A
	the appliance switches off automatically or can operate continuously without hazard		N/A
22.50	Controls incorporated in the appliance take priority over controls actuated by remote operation		N/A
22.51	There is a control on the appliance manually adjusted to the setting for remote operation before the appliance can be operated in this mode		N/A
	There is a visual indication showing that the appliance is adjusted for remote operation		N/A
	These requirements not necessary on appliances that can operate as follows, without giving rise to a hazard:		--
	- continuously, or		N/A
	- automatically, or		N/A

IEC 60335-2-14			
Clause	Requirement + Test	Result - Remark	Verdict
	- remotely		N/A
22.52	Socket-outlets on appliances accessible to the user in accordance with the socket-outlet system used in the country in which the appliance is sold		N/A
22.53	Class II appliances and class III appliances that incorporate functionally earthed parts have at least double insulation or reinforced insulation between live parts and the functionally earthed parts (IEC 60335-1/A1:2013)		N/A
22.54	Button cells and batteries designated R1 not accessible without the aid of a tool, unless (IEC 60335-1/A1:2013)		N/A
	the cover of their compartment can only be opened after at least two independent movements have been applied simultaneously (IEC 60335-1/A1:2013)		N/A
22.101	Appliances constructed so that lubricants are prevented from polluting food compartments (IEC 60335-2-14)		P
22.102	Appliances constructed so that food or liquids are prevented from penetrating into places that could cause electrical or mechanical faults. (IEC 60335-2-14)		P
22.103	The appliance coupler of cordless blenders shall be constructed to withstand the stresses occurring during normal use. (IEC 60335-2-14)		N/A
	The two live pins of the blender are connected together and an external resistive load is connected in series with the supply. The external load is such that the current is 1,1 times rated current.		N/A
	The blender is placed on its stand and withdrawn 10 000 times at a rate of approximately 10 times per minute. The test is continued for a further 10 000 times without current flowing.		N/A
	If the connection contacts cannot be energized when making or breaking the connection, instead of the above sequence, the test is carried out 20 000 times without current.		N/A
	After the test, the blender shall be suitable for further use and compliance with 8.1, 16.3, 27.5 and Clause 29 shall not be impaired.		N/A
22.104	Knife sharpeners shall be constructed so that knife blades are prevented from penetrating into areas that could cause an electrical or mechanical hazard (IEC 60335-2-14)		N/A
	Test probe D of IEC 61032 is inserted in any position through openings intended for sharpening		N/A

IEC 60335-2-14			
Clause	Requirement + Test	Result - Remark	Verdict
	It is not possible to touch live parts, electrical insulation or moving parts, other than a grinding wheel		N/A
23	INTERNAL WIRING		--
23.1	Wireways smooth and free from sharp edges		P
	Wires protected against contact with burrs, cooling fins etc.		P
	Wire holes in metal well-rounded or provided with bushings		N/A
	Wiring effectively prevented from coming into contact with moving parts		P
23.2	Beads etc. on live wires cannot change their position, and are not resting on sharp edges		N/A
	Beads inside flexible metal conduits contained within an insulating sleeve		N/A
23.3	Electrical connections and internal conductors movable relatively to each other not exposed to undue stress		N/A
	Flexible metallic tubes not causing damage to insulation of conductors		N/A
	Open-coil springs not used		N/A
	Adequate insulating lining provided inside a coiled spring, the turns of which touch one another		N/A
	No damage after 10 000 flexings for conductors flexed during normal use, or		N/A
	100 flexings for conductors flexed during user maintenance		N/A
	Electric strength test of 16.3, 1000 V between live parts and accessible metal parts		N/A
	Not more than 10% of the strands of any conductor broken, and		N/A
	not more than 30% for wiring supplying circuits that consume no more than 15W		N/A
23.4	Bare internal wiring sufficiently rigid and fixed		N/A
23.5	The insulation of internal wiring subjected to the supply mains voltage withstanding the electrical stress likely to occur in normal use		P
	Basic insulation electrically equivalent to the basic insulation of cords complying with IEC 60227 or IEC 60245, or		N/A

IEC 60335-2-14			
Clause	Requirement + Test	Result - Remark	Verdict
	no breakdown when a voltage of 2000 V is applied for 15 min between the conductor and metal foil wrapped around the insulation		P
	For class II construction, the requirements for supplementary insulation and reinforced insulation apply, (IEC 60335-1/A1:2013)		P
	except that the sheath of a cord complying with IEC 60227 or IEC 60245 may provide supplementary insulation. (IEC 60335-1/A1:2013)		N/A
	A single layer of internal wiring insulation does not provide reinforced insulation (IEC 60335-1/A1:2013)		P
23.6	Sleeving used as supplementary insulation on internal wiring retained in position by clamping at both ends, or		N/A
	be such that it can only be removed by breaking or cutting		P
23.7	The colour combination green/yellow only used for earthing conductors		N/A
23.8	Aluminium wires not used for internal wiring	No aluminium wire used	P
23.9	Stranded conductors not consolidated by soldering where they are subjected to contact pressure, unless		P
	the contact pressure is provided by spring terminals		N/A
23.10	The insulation and sheath of internal wiring, incorporated in external hoses for the connection of an appliance to the water mains, at least equivalent to that of light polyvinyl chloride sheathed flexible cord (60227 IEC 52)		N/A
24	COMPONENTS		--
24.1	Components comply with safety requirements in relevant IEC standards		P
	List of components..... :	(see appended table)	P
	Motors not required to comply with IEC 60034-1, they are tested as part of the appliance (IEC 60335-1/A1:2013)		P
	Relays tested as part of the appliance, or (IEC 60335-1/A1:2013)		N/A
	alternatively acc. to IEC 60730-1, and meeting the additional requirements in IEC 60335-1 (IEC 60335-1/A1:2013)		N/A
	The requirements of Clause 29 apply between live parts of components and accessible parts of the appliance (IEC 60335-1/A1:2013)		P

IEC 60335-2-14			
Clause	Requirement + Test	Result - Remark	Verdict
	Components can comply with the requirements for clearances and creepage distances for functional insulation in the relevant component standard (IEC 60335-1/A1:2013)		P
	30.2 of this standard apply to parts of non-metallic material in components including parts of non-metallic material supporting current-carrying connections (IEC 60335-1/A1:2013)		P
	Components that have not been previously tested to comply with the IEC standard for the relevant component are tested according to the requirements of 30.2 (IEC 60335-1/A1:2013)		P
	Components that have been previously tested to comply with the resistance to fire requirements in the IEC standard for the relevant component need not be retested provided the specified conditions are met (IEC 60335-1/A1:2013)		P
	If these conditions are not satisfied, the component is tested as part of the appliance. (IEC 60335-1/A1:2013)		P
	Power electronic converter circuits not required to comply with IEC 62477-1, they are tested as part of the appliance (IEC 60335-1/A1:2013)		N/A
	If components have not been tested and found to comply with relevant IEC standard for the number of cycles specified, they are tested in accordance with 24.1.1 to 24.1.9		N/A
	For components mentioned in 24.1.1 to 24.1.9 no additional tests specified in the relevant component standard are necessary other than those specified in 24.1.1 to 24.1.9		P
	Components not tested and found to comply with relevant IEC standard and components not marked or not used in accordance with its marking, tested under the conditions occurring in the appliance		P
	Lampholders and starterholders that have not being tested and found to comply with the relevant IEC standard, tested as a part of the appliance and additionally according to the gauging and interchangeability requirements of the relevant IEC standard		N/A
	No additional tests specified for nationally standardized plugs such as those detailed in IEC/TR 60083 or connectors complying with the standard sheets of IEC 60320-1 and IEC 60309		P

IEC 60335-2-14			
Clause	Requirement + Test	Result - Remark	Verdict
24.1.1	Capacitors likely to be permanently subjected to the supply voltage and used for radio interference suppression or for voltage dividing, complying with IEC 60384-14		P
	If the capacitors have to be tested, they are tested according to Annex F		N/A
24.1.2	Transformers in associated switch mode power supplies comply with Annex BB of IEC 61558-2-16 (IEC 60335-1/A1:2013)		N/A
	Safety isolating transformers complying with IEC 61558-2-6		N/A
	If they have to be tested, they are tested according to Annex G		N/A
24.1.3	Switches complying with IEC 61058-1, the number of cycles of operation being at least 10 000		P
	If they have to be tested, they are tested according to Annex H		N/A
	If the switch operates a relay or contactor, the complete switching system is subjected to the test		N/A
	If the switch only operates a motor starting relay complying with IEC 60730-2-10 with the number of cycles of a least 10 000 as specified, the complete switching system need not be tested		N/A
	Switches incorporated in the following appliances are tested for 3 000 cycles of operation: (IEC 60335-2-14)		—
	- bean slicers;		N/A
	- liquid blenders;		N/A
	- cheese graters;		N/A
	- graters;		N/A
	- ice-cream machines for use in refrigerators and freezers;		N/A
	- sieving machines;		N/A
	- shredders.		N/A
24.1.4	Automatic controls complying with IEC 60730-1 with the relevant part 2. The number of cycles of operation being at least:		--
	- thermostats: 1 0 000		N/A
	- temperature limiters: 1 000		N/A
	- self-resetting thermal cut-outs: 300		N/A
	- voltage maintained non-self-resetting thermal cut-outs: 1 000		N/A

IEC 60335-2-14			
Clause	Requirement + Test	Result - Remark	Verdict
	- other non-self-resetting thermal cut-outs: 30		N/A
	- timers: 3 000		N/A
	- energy regulators: 10 000		N/A
	The number of cycles for controls operating during clause 11 need not be declared, if the appliance meets the requirements of this standard when they are short-circuited		N/A
	Thermal motor protectors are tested in combination with their motor under the conditions specified in Annex D		N/A
	For water valves containing live parts and that are incorporated in external hoses for connection of an appliance to the water mains, the degree of protection declared for subclause 6.5.2 of IEC 60730-2-8 is IPX7		N/A
	Thermal cut-outs of the capillary type comply with the requirements for type 2.K controls in IEC 60730-2-9 (IEC 60335-1/A1:2013)		N/A
24.1.5	Appliance couplers complying with IEC 60320-1		N/A
	However, for class II appliances classified higher than IPX0, the appliance couplers comply with IEC 60320-2-3 (IEC 60335-1/A1:2013)		N/A
	Interconnection couplers complying with IEC 60320-2-2		N/A
24.1.6	Small lamp holders similar to E10 lampholders complying with IEC 60238, the requirements for E10 lampholders being applicable		N/A
24.1.7	For remote operation of the appliance via a telecommunication network, the relevant standard for the telecommunication interface circuitry in the appliance is IEC 62151		N/A
24.1.8	The relevant standard for thermal links is IEC 60691		N/A
	Thermal links not complying with IEC 60691 are considered to be an intentionally weak part for the purposes of Clause 19		N/A
24.1.9	Contactors and relays, other than motor starting relays, tested as part of the appliance		N/A
	They are also tested in accordance with Clause 17 of IEC 60730-1, the number of cycles of operations in 24.1.4 selected according to the contactor or relay function in the appliance		N/A
24.2	Appliances not fitted with:		--
	- switches or automatic controls in flexible cords		P

IEC 60335-2-14			
Clause	Requirement + Test	Result - Remark	Verdict
	- devices causing the protective device in the fixed wiring to operate in the event of a fault in the appliance		P
	- thermal cut-outs that can be reset by soldering, unless		N/A
	the solder has a melting point of at least 230 °C		N/A
24.3	Switches intended for all-pole disconnection of stationary appliances are directly connected to the supply terminals and have a contact separation in all poles, providing full disconnection under overvoltage category III conditions		N/A
24.4	Plugs and socket-outlets for extra-low voltage circuits and heating elements, not interchangeable with plugs and socket-outlets listed in IEC/TR 60083 or IEC 60906-1 or with connectors and appliance inlets complying with the standard sheets of IEC 60320-1		N/A
24.5	Capacitors in auxiliary windings of motors marked with their rated voltage and capacitance, and used accordingly		N/A
	Voltage across capacitors in series with a motor winding does not exceed 1,1 times rated voltage, when the appliance is supplied at 1,1 times rated voltage under minimum load		N/A
24.6	Working voltage of motors connected to the supply mains and having basic insulation that is inadequate for the rated voltage of the appliance, not exceeding 42 V		N/A
	In addition, the motors comply with the requirements of Annex I		N/A
24.7	Detachable hose-sets for connection of appliances to the water mains comply with IEC 61770		N/A
	They are supplied with the appliance		N/A
	Appliances intended to be permanently connected to the water mains not connected by a detachable hose-set		N/A
24.8	Motor running capacitors in appliances for which 30.2.3 is applicable and that are permanently connected in series with a motor winding, not causing a hazard in event of a failure		N/A
	One or more of the following conditions are to be met:		--
	- the capacitors are of class P2 according to IEC 60252-1		N/A
	- the capacitors are housed within a metallic or ceramic enclosure		N/A

IEC 60335-2-14			
Clause	Requirement + Test	Result - Remark	Verdict
	- the distance of separation of the outer surface to adjacent non-metallic parts exceeds 50 mm		N/A
	- adjacent non-metallic parts within 50 mm withstand the needle-flame test of Annex E		N/A
	- adjacent non-metallic parts within 50 mm classified as at least V-1 according to IEC 60695-11-10		N/A
25	SUPPLY CONNECTION AND EXTERNAL FLEXIBLE CORDS		--
25.1	Appliance not intended for permanent connection to fixed wiring, means for connection to the supply:		--
	- supply cord fitted with a plug, the current rating and voltage rating of the plug being not less than the corresponding ratings of its associated appliance (IEC 60335-1/A1:2013)		P
	- an appliance inlet having at least the same degree of protection against moisture as required for the appliance, or		N/A
	- pins for insertion into socket-outlets		N/A
	Ice-cream machines for use in refrigerators and freezers and hand-held appliances: no appliance inlet. (IEC 60335-2-14)		N/A
25.2	Appliance not provided with more than one means of connection to the supply mains		P
	Stationary appliance for multiple supply may be provided with more than one means of connection, provided electric strength test of 1250 V for 1 min between each means of connection causes no breakdown		N/A
25.3	Appliance intended to be permanently connected to fixed wiring provided with one of the following means for connection to the supply mains:		--
	- a set of terminals allowing the connection of a flexible cord		N/A
	- a fitted supply cord		N/A
	- a set of supply leads accommodated in a suitable compartment		N/A
	- a set of terminals for the connection of cables of fixed wiring, cross-sectional areas specified in 26.6, and the appliance allows the connection of the supply conductors after the appliance has been fixed to its support		N/A

IEC 60335-2-14			
Clause	Requirement + Test	Result - Remark	Verdict
	- a set of terminals and cable entries, conduit entries, knock-outs or glands, allowing connection of appropriate types of cable or conduit, and the appliance allows the connection of the supply conductors after the appliance has been fixed to its support		N/A
	For a fixed appliance constructed so that parts can be removed to facilitate easy installation, this requirement is met if it is possible to connect the fixed wiring without difficulty after a part of the appliance has been fixed to its support		N/A
25.4	Cable and conduit entries, rated current of appliance not exceeding 16 A, dimension according to table 10 (mm)..... :		N/A
	Introduction of conduit or cable does not reduce clearances or creepage distances below values specified in clause 29		N/A
25.5	Method for assembling the supply cord to the appliance:		--
	- type X attachment		N/A
	- type Y attachment		P
	- type Z attachment, if allowed in relevant part 2		N/A
	Type X attachment, other than those with a specially prepared cord, not used for flat twin tinsel cords		N/A
	For multi-phase appliances supplied with a supply cord and that are intended to be permanently connected to fixed wiring, the supply cord is assembled to the appliance by type Y attachment		N/A
	Type Z attachment allowed for : (IEC 60335-2-14)		N/A
	- can openers		N/A
	- coffee mills and grain grinders having a mass not exceeding 1.5 kg		N/A
	- cream whippers		N/A
	- egg beaters		N/A
	- ice-cream machines including those for use in refrigerators and freezers		N/A
	- knife sharpeners		N/A
	Type X attachments, other than those with a specially prepared cord, not used for ice-cream machines for use in refrigerators and freezers. (IEC 60335-2-14)		N/A
25.6	Plugs fitted with only one flexible cord		P
25.7	Supply cords, other than for class III appliances, being one of the following types:		--

IEC 60335-2-14			
Clause	Requirement + Test	Result - Remark	Verdict
	- rubber sheathed (at least 60245 IEC 53)		N/A
	- polychloroprene sheathed (at least 60245 IEC 57)		N/A
	- polyvinyl chloride sheathed. Not used if they are likely to touch metal parts having a temperature rise exceeding 75 K during the test of clause 11		--
	<ul style="list-style-type: none"> light polyvinyl chloride sheathed cord (60227 IEC 52), for appliances not exceeding 3 kg 		N/A
	<ul style="list-style-type: none"> ordinary polyvinyl chloride sheathed cord (60227 IEC 53), for other appliances 	H05VVH2-F 60227 IEC 53	P
	- heat resistant polyvinyl chloride sheathed. Not used for type X attachment other than specially prepared cords		--
	<ul style="list-style-type: none"> heat-resistant light polyvinyl chloride sheathed cord (60227 IEC 56), for appliances not exceeding 3 kg 		N/A
	<ul style="list-style-type: none"> heat-resistant polyvinyl chloride sheathed cord (60227 IEC 57), for other appliances 		N/A
	Supply cords for class III appliances adequately insulated		N/A
	Test with 500 V for 2 min for supply cords of class III appliances that contain live parts		N/A
	Polyvinyl chloride sheathed supply cords of ice-cream machines for use in refrigerators and freezers are resistant to low temperatures: comply with tests 8.1, 8.2 and 8.3 of IEC 60811-504:2012 and 4.2 of IEC 60811-505:2012, carried out at a temperature of $-25\text{ °C} \pm 2\text{ °C}$. (IEC 60335-2-14, Ed. 6)		N/A
25.8	Nominal cross-sectional area of supply cords not less than table 11; rated current (A); cross-sectional area (mm ²)	Rated current: 2,51 A; Cross-sectional: 0,75 mm ²	P
25.9	Supply cords not in contact with sharp points or edges		P
25.10	Supply cord of class I appliances have a green/yellow core for earthing		N/A
	In multi-phase appliances, the colour of the neutral conductor of the supply cord is blue (IEC 60335-1/A1:2013)		N/A
25.11	Conductors of supply cords not consolidated by soldering where they are subject to contact pressure, unless		P
	the contact pressure is provided by spring terminals		N/A
25.12	Insulation of the supply cord not damaged when moulding the cord to part of the enclosure		N/A

IEC 60335-2-14			
Clause	Requirement + Test	Result - Remark	Verdict
25.13	Inlet openings so constructed as to prevent damage to the supply cord		P
	If it is not evident that the supply cord can be introduced without risk of damage, a non-detachable lining or bushing complying with 29.3 for supplementary insulation provided (IEC 60335-1/A1:2013)		N/A
	If unsheathed supply cord, a similar additional bushing or lining is required, unless the appliance is		N/A
	class 0, or		N/A
	a class III appliance not containing live parts		N/A
25.14	Supply cords moved while in operation adequately protected against excessive flexing		N/A
	Flexing test, as described:		--
	- applied force (N)		N/A
	- number of flexings		N/A
	The test does not result in:		--
	- short-circuit between the conductors, such that the current exceeds a value of twice the rated current		N/A
	- breakage of more than 10% of the strands of any conductor		N/A
	- separation of the conductor from its terminal		N/A
	- loosening of any cord guard		N/A
	- damage to the cord or the cord guard		N/A
	- broken strands piercing the insulation and becoming accessible		N/A
	Hand-held blenders and hand-held mixers subjected to 2000 flexings as specified in IEC 60335-2-14, while mounted on an apparatus similar to that of Figure 8. (IEC 60335-2-14)		N/A
25.15	For appliances with supply cord and appliances to be permanently connected to fixed wiring by a flexible cord, conductors of the supply cord relieved from strain, twisting and abrasion by use of cord anchorage		P
	The cord cannot be pushed into the appliance to such an extent that the cord or internal parts of the appliance can be damaged		P
	Pull and torque test of supply cord:		--

IEC 60335-2-14			
Clause	Requirement + Test	Result - Remark	Verdict
	- fixed appliances: pull 100 N; torque (not on automatic cord reel) (Nm) (IEC 60335-1/A1:2013)		N/A
	- other appliances: values shown in table 12: mass (kg); pull (N); torque (not on automatic cord reel) (Nm) (IEC 60335-1/A1:2013).....	3,1kg; pull: 60 N; torque: 0,25 Nm	P
	Cord not damaged and max. 2 mm displacement of the cord	1,0 mm	P
25.16	Cord anchorages for type X attachments constructed and located so that:		--
	- replacement of the cord is easily possible		N/A
	- it is clear how the relief from strain and the prevention of twisting are obtained		N/A
	- they are suitable for different types of supply cord		N/A
	- cord cannot touch the clamping screws of cord anchorage if these screws are accessible, unless		N/A
	they are separated from accessible metal parts by supplementary insulation		N/A
	- the cord is not clamped by a metal screw which bears directly on the cord		N/A
	- at least one part of the cord anchorage securely fixed to the appliance, unless		N/A
	it is part of a specially prepared cord		N/A
	- screws which have to be operated when replacing the cord do not fix any other component, unless		N/A
	the appliance becomes inoperative or incomplete or the parts cannot be removed without a tool		N/A
	- if labyrinths can be bypassed the test of 25.15 is nevertheless withstood		N/A
	- for class 0, 0I and I appliances they are of insulating material or are provided with an insulating lining, unless		N/A
	failure of the insulation of the cord does not make accessible metal parts live		N/A
	- for class II appliances they are of insulating material, or		N/A
	if of metal, they are insulated from accessible metal parts by supplementary insulation		N/A
	After the test of 25.15, under the conditions specified, the conductors have not moved by more than 1 mm in the terminals		N/A

IEC 60335-2-14			
Clause	Requirement + Test	Result - Remark	Verdict
25.17	Adequate cord anchorages for type Y and Z attachment, test with the cord supplied with the appliance	Type Y	P
25.18	Cord anchorages only accessible with the aid of a tool, or		P
	Constructed so that the cord can only be fitted with the aid of a tool		N/A
25.19	Type X attachment, glands not used as cord anchorage in portable appliances		N/A
	Tying the cord into a knot or tying the cord with string not used		N/A
25.20	The conductors of the supply cord for type Y and Z attachment insulated from accessible metal parts (IEC 60335-1/A1:2013)		P
25.21	Space for supply cord for type X attachment or for connection of fixed wiring constructed:		--
	- to permit checking of conductors with respect to correct positioning and connection before fitting any cover		N/A
	- so there is no risk of damage to the conductors or their insulation when fitting the cover		N/A
	- for portable appliances, so that the uninsulated end of a conductor, if it becomes free from the terminal, prevented from contact with accessible metal parts		N/A
	2 N test to the conductor for portable appliances; no contact with accessible metal parts		N/A
25.22	Appliance inlets:		--
	- live parts not accessible during insertion or removal		N/A
	Requirement not applicable to appliance inlets complying with IEC 60320-1		N/A
	- connector can be inserted without difficulty		N/A
	- the appliance is not supported by the connector		N/A
	- not for cold conditions if temp. rise of external metal parts exceeds 75 K during clause 11, unless the supply cord is unlikely to touch such metal parts		N/A
	- located so that pollution by food or liquid is unlikely to occur during normal use. (IEC 60335-2-14)		N/A
25.23	Interconnection cords comply with the requirements for the supply cord, except that:		N/A

IEC 60335-2-14			
Clause	Requirement + Test	Result - Remark	Verdict
	- the cross-sectional area of the conductors is determined on the basis of the maximum current during clause 11		N/A
	- the thickness of the insulation may be reduced		N/A
	If necessary, electric strength test of 16.3		N/A
25.24	Interconnection cords not detachable without the aid of a tool if compliance with this standard is impaired when they are disconnected		N/A
25.25	Dimensions of pins that are inserted into socket-outlets compatible with the dimensions of the relevant socket-outlet.		N/A
	Dimensions of pins and engagement face in accordance with the dimensions of the relevant plug in IEC/TR 60083		N/A
26	TERMINALS FOR EXTERNAL CONDUCTORS		--
26.1	Appliances provided with terminals or equally effective devices for connection of external conductors		P
	Terminals only accessible after removal of a non-detachable cover, except		P
	for class III appliances that do not contain live parts		N/A
	Earthing terminals may be accessible if a tool is required to make the connections and means are provided to clamp the wire independently from its connection		N/A
26.2	Appliances with type X attachment and appliances for the connection of cables to fixed wiring provided with terminals in which connections are made by means of screws, nuts or similar devices, unless		N/A
	the connections are soldered		N/A
	Screws and nuts not used to fix any other component, except		N/A
	internal conductors, if so arranged that they are unlikely to be displaced when fitting the supply conductors		N/A
	If soldered connections used, the conductor so positioned or fixed that reliance is not placed on soldering alone, unless		N/A
	barriers provided so that neither clearances nor creepage distances between live parts and other metal parts reduced below the values for supplementary insulation if the conductor becomes free at the soldered joint		N/A

IEC 60335-2-14			
Clause	Requirement + Test	Result - Remark	Verdict
26.3	Terminals for type X attachment and for connection of cables of fixed wiring so constructed that the conductor is clamped between metal surfaces with sufficient contact pressure but without damaging the conductor		N/A
	Terminals fixed so that when the clamping means is tightened or loosened:		--
	- the terminal does not become loose		N/A
	- internal wiring is not subjected to stress		N/A
	- neither clearances nor creepage distances are reduced below the values in clause 29		N/A
	Compliance checked by inspection and by the test of subclause 9.6 of IEC 60999-1, the torque applied being equal to two-thirds of the torque specified (Nm)		N/A
	No deep or sharp indentations of the conductors		N/A
26.4	Terminals for type X attachment, except those having a specially prepared cord and those for the connection of cables of fixed wiring, no special preparation of conductors such as by soldering, use of cable lugs, eyelets or similar, and		N/A
	so constructed or placed that conductors prevented from slipping out when clamping screws or nuts are tightened		N/A
26.5	Terminals for type X attachment so located or shielded that if a wire of a stranded conductor escapes, no risk of accidental connection to other parts that result in a hazard		N/A
	Stranded conductor test, 8 mm insulation removed		N/A
	No contact between live parts and accessible metal parts and,		N/A
	for class II constructions, between live parts and metal parts separated from accessible metal parts by supplementary insulation only		N/A
26.6	Terminals for type X attachment and for connection of cables of fixed wiring suitable for connection of conductors with cross-sectional area according to table 13; rated current (A); nominal cross-sectional area (mm ²)		N/A
	If a specially prepared cord is used, terminals need only be suitable for that cord		N/A
26.7	Terminals for type X attachment, except in class III appliances not containing live parts, accessible after removal of a cover or part of the enclosure		N/A

IEC 60335-2-14			
Clause	Requirement + Test	Result - Remark	Verdict
26.8	Terminals for the connection of fixed wiring, including the earthing terminal, located close to each other		N/A
26.9	Terminals of the pillar type constructed and located as specified		N/A
26.10	Terminals with screw clamping and screwless terminals not used for flat twin tinsel cords, unless		N/A
	conductors ends fitted with means suitable for screw terminals		N/A
	Pull test of 5 N to the connection		N/A
26.11	For type Y and Z attachment, soldered, welded, crimped or similar connections may be used		P
	For Class II appliances, the conductor so positioned or fixed that reliance is not placed on soldering, welding or crimping alone		P
	If soldering, welding or crimping alone used, barriers provided so that clearances and creepage distances between live parts and other metal parts are not reduced below the values for supplementary insulation if the conductor becomes free		N/A
27	PROVISION FOR EARTHING		--
27.1	Accessible metal parts of Class 0I and I appliances permanently and reliably connected to an earthing terminal or earthing contact of the appliance inlet		N/A
	Earthing terminals and earthing contacts not connected to the neutral terminal		N/A
	Class 0, II and III appliances have no provision for earthing	Class II appliance	P
	Class II appliances and class III appliances can incorporate an earth for functional purposes (IEC 60335-1/A1:2013)		N/A
	Safety extra-low voltage circuits not earthed, unless		N/A
	protective extra-low voltage circuits		N/A
27.2	Clamping means of earthing terminals adequately secured against accidental loosening		N/A
	Terminals for the connection of external equipotential bonding conductors allow connection of conductors of 2.5 to 6 mm ² , and		N/A
	do not provide earthing continuity between different parts of the appliance, and		N/A
	conductors cannot be loosened without the aid of a tool		N/A

IEC 60335-2-14			
Clause	Requirement + Test	Result - Remark	Verdict
	Requirements not applicable to class II appliances and class III appliances that incorporate an earth for functional purposes (IEC 60335-1/A1:2013)		N/A
27.3	For a detachable part having an earth connection and being plugged into another part of the appliance, the earth connection is made before and separated after current-carrying connections when removing the part		N/A
	For appliances with supply cords, current-carrying conductors become taut before earthing conductor, if the cord slips out of the cord anchorage		N/A
	Requirements not applicable to class II appliances and class III appliances that incorporate an earth for functional purposes (IEC 60335-1/A1:2013)		N/A
27.4	No risk of corrosion resulting from contact between parts of the earthing terminal and the copper of the earthing conductor or other metal		N/A
	Parts providing earthing continuity, other than parts of a metal frame or enclosure, have adequate resistance to corrosion		N/A
	If of steel, these parts provided with an electroplated coating with a thickness at least 5 µm		N/A
	Adequate protection against rusting of parts of coated or uncoated steel, only intended to provide or transmit contact pressure		N/A
	In the body of the earthing terminal is a part of a frame or enclosure of aluminium or aluminium alloys, precautions taken to avoid risk of corrosion		N/A
	Requirements not applicable to class II appliances and class III appliances that incorporate an earth for functional purposes (IEC 60335-1/A1:2013)		N/A
27.5	Low resistance of connection between earthing terminal and earthed metal parts		N/A
	This requirement does not apply to connections providing earthing continuity in the protective extra-low voltage circuit, provided the clearances of basic insulation are based on the rated voltage of the appliance		N/A
	Requirements not applicable to class II appliances and class III appliances that incorporate an earth for functional purposes (IEC 60335-1/A1:2013)		N/A
	Resistance not exceeding 0,1 Ω at the specified low-resistance test (Ω)		N/A

IEC 60335-2-14			
Clause	Requirement + Test	Result - Remark	Verdict
27.6	The printed conductors of printed circuit boards not used to provide earthing continuity in hand-held appliances.		N/A
	They may be used to provide earthing continuity in other appliances if at least two tracks are used with independent soldering points and the appliance complies with 27.5 for each circuit		N/A
	Requirements not applicable to class II appliances and class III appliances that incorporate an earth for functional purposes (IEC 60335-1/A1:2013)		N/A
28	SCREWS AND CONNECTIONS		--
28.1	Fixings, electrical connections and connections providing earthing continuity withstand mechanical stresses		P
	Screws not of soft metal liable to creep, such as zinc or aluminium		P
	Diameter of screws of insulating material min. 3 mm		N/A
	Screws of insulating material not used for any electrical connections or connections providing earthing continuity		N/A
	Screws used for electrical connections or connections providing earthing continuity screwed into metal		N/A
	Screws not of insulating material if their replacement by a metal screw can impair supplementary or reinforced insulation		N/A
	For type X attachment, screws to be removed for replacement of supply cord or for user maintenance, not of insulating material if their replacement by a metal screw impairs basic insulation		N/A
	For screws and nuts; torque-test as specified in table 14		N/A
28.2	Electrical connections and connections providing earthing continuity constructed so that contact pressure is not transmitted through non-ceramic insulating material liable to shrink or distort, unless		P
	there is resiliency in the metallic parts to compensate for shrinkage or distortion of the insulating material		N/A
	This requirement does not apply to electrical connections in circuits of appliances for which:		--
	<ul style="list-style-type: none"> 30.2.2 is applicable and that carry a current not exceeding 0,5 A 		N/A

IEC 60335-2-14			
Clause	Requirement + Test	Result - Remark	Verdict
	<ul style="list-style-type: none"> 30.2.3 is applicable and that carry a current not exceeding 0,2 A 		N/A
28.3	Space-threaded (sheet metal) screws only used for electrical connections if they clamp the parts together		N/A
	Thread-cutting (self-tapping) screws and thread rolling screws only used for electrical connections if they generate a full form standard machine screw thread		N/A
	Thread-cutting (self-tapping) screws not used if they are likely to be operated by the user or installer		N/A
	Thread-cutting, thread rolling and space threaded screws may be used in connections providing earthing continuity provided it is not necessary to disturb the connection:		--
	- in normal use,		N/A
	- during user maintenance,		N/A
	- when replacing a supply cord having a type X attachment, or		N/A
	- during installation		N/A
	At least two screws being used for each connection providing earthing continuity, unless		N/A
	the screw forms a thread having a length of at least half the diameter of the screw		N/A
28.4	Screws and nuts that make mechanical connection secured against loosening if they also make electrical connections or connections providing earthing continuity		N/A
	This requirement does not apply to screws in the earthing circuit if at least two screws are used, or		N/A
	if an alternative earthing circuit is provided		N/A
	Rivets for electrical connections or connections providing earthing continuity secured against loosening if the connections are subjected to torsion		N/A
29	CLEARANCES, CREEPAGE DISTANCES AND SOLID INSULATION		--
	Clearances, creepage distances and solid insulation withstand electrical stress		P
	For coatings used on printed circuits boards to protect the microenvironment (Type 1) or to provide basic insulation (Type 2), Annex J applies		N/A
	The microenvironment is pollution degree 1 under type 1 protection		N/A

IEC 60335-2-14			
Clause	Requirement + Test	Result - Remark	Verdict
	For type 2 protection, the spacing between the conductors before the protection is applied is not less than the values specified in Table 1 of IEC 60664-3		N/A
	These values apply to functional, basic, supplementary and reinforced insulation		N/A
29.1	Clearances not less than the values specified in table 16, taking into account the rated impulse voltage for the overvoltage categories of table 15, unless.....	(see appended table)	P
	for basic insulation and functional insulation they comply with the impulse voltage test of clause 14		N/A
	However, if the distances are affected by wear, distortion, movement of the parts or during assembly, the clearances for rated impulse voltages of 1500V and above are increased by 0,5 mm and the impulse voltage test is not applicable		P
	For appliances intended for use at altitudes exceeding 2 000 m, the clearances in Table 16 is increased according to the relevant multiplier values in Table A.2 of IEC 60664-1 (IEC 60335-1/A1:2013)		N/A
	Impulse voltage test is not applicable:		--
	- when the microenvironment is pollution degree 3, or		P
	- for basic insulation of class 0 and class 01 appliances		N/A
	- to appliances intended for use at altitudes exceeding 2 000 m (IEC 60335-1/A1:2013)		N/A
	Appliances are in overvoltage category II		P
	A force of 2 N is applied to bare conductors, other than heating elements		P
	A force of 30 N is applied to accessible surfaces		P
29.1.1	Clearances of basic insulation withstand the overvoltages, taking into account the rated impulse voltage	(see appended table)	P
	The values of table 16 or the impulse voltage test of clause 14 are applicable		N/A
	Clearance at the terminals of tubular sheathed heating elements may be reduced to 1,0 mm if the microenvironment is pollution degree 1		N/A
	Lacquered conductors of windings considered to be bare conductors		P

IEC 60335-2-14			
Clause	Requirement + Test	Result - Remark	Verdict
29.1.2	Clearances of supplementary insulation not less than those specified for basic insulation in table 16	(see appended table)	P
29.1.3	Clearances of reinforced insulation not less than those specified for basic insulation in table 16, using the next higher step for rated impulse voltage	(see appended table)	P
	For double insulation, with no intermediate conductive part between basic and supplementary insulation, clearances are measured between live parts and the accessible surface, and the insulation system is treated as reinforced insulation		P
29.1.4	Clearances for functional insulation are the largest values determined from:		--
	- table 16 based on the rated impulse voltage..... :	(see appended table)	P
	- table F.7a in IEC 60664-1, frequency not exceeding 30 kHz		P
	- clause 4 of IEC 60664-4, frequency exceeding 30 kHz		N/A
	If values of table 16 are largest, the impulse voltage test of clause 14 may be applied instead, unless		N/A
	the microenvironment is pollution degree 3, or		P
	the distances can be affected by wear, distortion, movement of the parts or during assembly		P
	However, clearances are not specified if the appliance complies with clause 19 with the functional insulation short-circuited		N/A
	Lacquered conductors of windings considered to be bare conductors		P
	However, clearances at crossover points are not measured		P
	Clearance between surfaces of PTC heating elements may be reduced to 1mm		N/A
29.1.5	Appliances having higher working voltages than rated voltage, clearances for basic insulation are the largest values determined from:		--
	- table 16 based on the rated impulse voltage..... :		N/A
	- table F.7a in IEC 60664-1, frequency not exceeding 30 kHz		N/A
	- clause 4 of IEC 60664-4, frequency exceeding 30 kHz		N/A

IEC 60335-2-14			
Clause	Requirement + Test	Result - Remark	Verdict
	If clearances for basic insulation are selected from Table F.7a of IEC 60664-1 or Clause 4 of IEC 60664-4, the clearances of supplementary insulation are not less than those specified for basic insulation		N/A
	If clearances for basic insulation are selected from Table F.7a of IEC 60664-1, the clearances of reinforced insulation dimensioned as specified in Table F.7a are to withstand 160% of the withstand voltage required for basic insulation		N/A
	If clearances for basic insulation are selected from Clause 4 of IEC 60664-4, the clearances of reinforced insulation are twice the value required for basic insulation		N/A
	If the secondary winding of a step-down transformer is earthed, or if there is an earthed screen between the primary and secondary windings, clearances of basic insulation on the secondary side not less than those specified in table 16, but using the next lower step for rated impulse voltage		N/A
	Circuits supplied with a voltage lower than rated voltage, clearances of functional insulation are based on the working voltage used as the rated voltage in table 15		N/A
29.2	Creepage distances not less than those appropriate for the working voltage, taking into account the material group and the pollution degree	(see appended table)	P
	Pollution degree 2 applies, unless		N/A
	- precautions taken to protect the insulation; pollution degree 1		N/A
	- insulation subjected to conductive pollution; pollution degree 3		P
	A force of 2 N is applied to bare conductors, other than heating elements		P
	A force of 30 N is applied to accessible surfaces		P
	In a double insulation system, the working voltage for both the basic and supplementary insulation is taken as the working voltage across the complete double insulation system		P
	Microenvironment is pollution degree 3 (IEC 60335-2-14)		P
	unless insulation enclosed or located so that it is unlikely to be exposed to pollution during normal use of the appliance (IEC 60335-2-14)		N/A

IEC 60335-2-14			
Clause	Requirement + Test	Result - Remark	Verdict
29.2.1	Creepage distances of basic insulation not less than specified in table 17	(see appended table)	P
	However, if the working voltage is periodic and has a frequency exceeding 30 kHz, the creepage distances are also determined from table 2 of IEC 60664-4, these values being used if exceeding the values in table 17		N/A
	Except for pollution degree 1, corresponding creepage distance not less than the minimum specified for the clearance in table 16, if the clearance has been checked according to the test of clause 14.....		N/A
29.2.2	Creepage distances of supplementary insulation at least those specified for basic insulation in table 17, or.....	(see appended table)	P
	Table 2 of IEC 60664-4, as applicable.....		N/A
29.2.3	Creepage distances of reinforced insulation at least double those specified for basic insulation in table 17, or.....	(see appended table)	P
	Table 2 of IEC 60664-4, as applicable.....		N/A
29.2.4	Creepage distances of functional insulation not less than specified in table 18	(see appended table)	P
	However, if the working voltage is periodic and has a frequency exceeding 30 kHz, the creepage distances are also determined from table 2 of IEC 60664-4, these values being used if exceeding the values in table 18		N/A
	Creepage distances may be reduced if the appliance complies with clause 19 with the functional insulation short-circuited		N/A
29.3	Supplementary and reinforced insulation have adequate thickness, or a sufficient number of layers, to withstand the electrical stresses		P
	Compliance checked:		--
	- by measurement, in accordance with 29.3.1, or		P
	- by an electric strength test in accordance with 29.3.2, or		N/A
	- for insulation, other than single layer internal wiring insulation, by an assessment of the thermal quality of the material combined with an electric strength test, in accordance with 29.3.3, and (IEC 60335-1/A1:2013)		N/A
	for accessible parts of reinforced insulation consisting of a single layer, by measurement in accordance with 29.3.4, or		N/A

IEC 60335-2-14			
Clause	Requirement + Test	Result - Remark	Verdict
	- by an assessment of the thermal quality of the material according to 29.3.3 combined with an electric strength test in accordance with 23.5, for each single layer internal wiring insulation touching each other, or (IEC 60335-1/A1:2013)		N/A
	- as specified in subclause 6.3 of IEC 60664-4 for insulation that is subjected to any periodic voltage having a frequency exceeding 30 kHz		N/A
29.3.1	Supplementary insulation have a thickness of at least 1 mm	Plastic enclosure: 2,6 mm	P
	Reinforced insulation have a thickness of at least 2 mm		N/A
29.3.2	Each layer of material withstand the electric strength test of 16.3 for supplementary insulation		N/A
	Supplementary insulation consist of at least 2 layers		N/A
	Reinforced insulation consist of at least 3 layers		N/A
29.3.3	The insulation is subjected to the dry heat test Bb of IEC 60068-2-2, followed by		N/A
	the electric strength test of 16.3		N/A
	If the temperature rise during the tests of clause 19 does not exceed the value specified in table 3, the test of IEC 60068-2-2 is not carried out		N/A
29.3.4	Thickness of accessible parts of reinforced insulation consisting of a single layer not less than specified in table 19		N/A
30	RESISTANCE TO HEAT AND FIRE		--
30.1	External parts of non-metallic material,		P
	parts supporting live parts, and		P
	parts of thermoplastic material providing supplementary or reinforced insulation		P
	sufficiently resistant to heat		P
	Ball-pressure test according to IEC 60695-10-2		P
	External parts tested at 40 °C plus the maximum temperature rise determined during the test of clause 11, or at 75 °C, whichever is the higher; temperature (°C)	(see appended table)	P
	Parts supporting live parts tested at 40°C plus the maximum temperature rise determined during the test of clause 11, or at 125 °C, whichever is the higher; temperature (°C).....	(see appended table)	P

IEC 60335-2-14			
Clause	Requirement + Test	Result - Remark	Verdict
	Parts of thermoplastic material providing supplementary or reinforced insulation tested at 25 °C plus the maximum temperature rise determined during clause 19, if higher; temperature (°C)..... :		N/A
	For ice-cream machines for use in refrigerators and freezers, temperature of 40 °C instead of 10 °C. (IEC 60335-2-14)		N/A
30.2	Parts of non-metallic material resistant to ignition and spread of fire		P
	This requirement does not apply to:		--
	parts having a mass not exceeding 0,5 g, provided the cumulative effect is unlikely to propagate flames that originate inside the appliance by propagating flames from one part to another, or		N/A
	decorative trims, knobs and other parts unlikely to be ignited or to propagate flames that originate inside the appliance		P
	Compliance checked by the test of 30.2.1, and in addition:		P
	- for attended appliances, 30.2.2 applies		P
	- for unattended appliances, 30.2.3 applies		N/A
	For appliances for remote operation, 30.2.3 applies		N/A
	For base material of printed circuit boards, 30.2.4 applies		P
	For churns and ice-cream machines, 30.2.3 is applicable. (IEC 60335-2-14)		N/A
30.2.1	Parts of non-metallic material subjected to the glow-wire test of IEC 60695-2-11 at 550 °C	(See appended table)	P
	However, test not carried out if the material is classified as having a glow-wire flammability index according to IEC 60695-2-12 of at least 550 °C, or		N/A
	the material is classified at least HB40 according to IEC 60695-11-10		N/A
	Parts for which the glow-wire test cannot be carried out need to meet the requirements in ISO 9772 for material classified HBF		N/A
30.2.2	Appliances operated while attended, parts of non-metallic material supporting current-carrying connections, and		P
	parts of non-metallic material within a distance of 3mm of such connections,		P
	subjected to the glow-wire test of IEC 60695-2-11		P

IEC 60335-2-14			
Clause	Requirement + Test	Result - Remark	Verdict
	The test severity is:		--
	- 750 °C, for connections carrying a current exceeding 0,5 A during normal operation	(See appended table)	P
	- 650 °C, for other connections	(See appended table)	P
	Glow-wire applied to an interposed shielding material, if relevant		N/A
	The glow-wire test is not carried out on parts of material classified as having a glow-wire flammability index according to IEC 60695-2-12 of at least:		--
	- 750 °C, for connections carrying a current exceeding 0,5 A during normal operation		N/A
	- 650 °C, for other connections		N/A
	The glow-wire test is also not carried out on small parts. These parts are to:		--
	- comprise material having a glow-wire flammability index of at least 750 °C, or 650 °C as appropriate, or		N/A
	- comply with the needle-flame test of Annex E, or		N/A
	- comprise material classified as V-0 or V-1 according to IEC 60695-11-10..... :		N/A
	Glow-wire test not applicable to conditions as specified..... :		N/A
30.2.3	Appliances operated while unattended, tested as specified in 30.2.3.1 and 30.2.3.2		N/A
	The tests are not applicable to conditions as specified..... :		N/A
30.2.3.1	Parts of non-metallic material supporting connections carrying a current exceeding 0,2 A during normal operation, and		N/A
	parts of non-metallic material, other than small parts, within a distance of 3 mm,		N/A
	subjected to the glow-wire test of IEC 60695-2-11 with a test severity of 850 °C		N/A
	Glow-wire applied to an interposed shielding material, if relevant		N/A
	The glow-wire test is not carried out on parts of material classified as having a glow-wire flammability index according to IEC 60695-2-12 of at least 850 °C		N/A
30.2.3.2	Parts of non-metallic material supporting connections, and		N/A
	parts of non-metallic material within a distance of 3mm,		N/A

IEC 60335-2-14			
Clause	Requirement + Test	Result - Remark	Verdict
	subjected to glow-wire test of IEC 60695-2-11		N/A
	The test severity is:		--
	- 750 °C, for connections carrying a current exceeding 0,2 A during normal operation		N/A
	- 650 °C, for other connections		N/A
	Glow-wire applied to an interposed shielding material, if relevant		N/A
	However, the glow-wire test of 750 °C or 650 °C as appropriate, is not carried out on parts of material fulfilling both or either of the following classifications:		--
	- a glow-wire ignition temperature according to IEC 60695-2-13 of at least:		N/A
	<ul style="list-style-type: none"> • 775 °C, for connections carrying a current exceeding 0,2 A during normal operation 		N/A
	<ul style="list-style-type: none"> • 675 °C, for other connections 		N/A
	- a glow-wire flammability index according to IEC 60695-2-12 of at least:		N/A
	- 750 °C, for connections carrying a current exceeding 0,2 A during normal operation		N/A
	- 650 °C, for other connections		N/A
	The glow-wire test is also not carried out on small parts. These parts are to:		--
	- comprise material having a glow-wire ignition temperature of at least 775 °C or 675 °C as appropriate, or		N/A
	- comprise material having a glow-wire flammability index of at least 750 °C or 650 °C as appropriate, or		N/A
	- comply with the needle-flame test of Annex E, or		N/A
	- comprise material classified as V-0 or V-1 according to IEC 60695-11-10		N/A
	The consequential needle-flame test of Annex E applied to non-metallic parts that encroach within the vertical cylinder placed above the centre of the connection zone and on top of the non-metallic parts supporting current-carrying connections, and parts of non-metallic material within a distance of 3 mm of such connections if these parts are those:		--
	- parts that withstood the glow-wire test of IEC 60695-2-11 of 750 °C or 650 °C as appropriate, but produce a flame that persist longer than 2 s, or		N/A
	- parts that comprised material having a glow-wire flammability index of at least 750 °C or 650 °C as appropriate, or		N/A

IEC 60335-2-14			
Clause	Requirement + Test	Result - Remark	Verdict
	- small parts, that comprised material having a glow-wire flammability index of at least 750 °C or 650 °C as appropriate, or		N/A
	- small parts for which the needle-flame test of Annex E was applied, or		N/A
	- small parts for which a material classification of V-0 or V-1 was applied		N/A
	However, the consequential needle-flame test is not carried out on non-metallic parts, including small parts, within the cylinder that are:		--
	- parts having a glow-wire ignition temperature of at least 775 °C or 675 °C as appropriate, or		N/A
	- parts comprising material classified as V-0 or V-1 according to IEC 60695-11-10, or		N/A
	- parts shielded by a flame barrier that meets the needle-flame test of Annex E or that comprises material classified as V-0 or V-1 according to IEC 60695-11-10		N/A
30.2.4	Base material of printed circuit boards subjected to the needle-flame test of Annex E		P
	Test not applicable to conditions as specified		N/A
31	RESISTANCE TO RUSTING		--
	Relevant ferrous parts adequately protected against rusting		P
	Tests specified in part 2 when necessary		N/A
32	RADIATION, TOXICITY AND SIMILAR HAZARDS		--
	Appliance does not emit harmful radiation or present a toxic or similar hazard due to their operation in normal use		P
	Compliance is checked by the limits or tests specified in part 2, if relevant		N/A
A	ANNEX A (INFORMATIVE) ROUTINE TESTS		--
	Description of routine tests to be carried out by the manufacturer		N/A
B	ANNEX B (NORMATIVE) APPLIANCES POWERED BY RECHARGEABLE BATTERIES THAT ARE RECHARGED IN THE APPLIANCE		--
	The following modifications to this standard are applicable for appliances powered by batteries that are recharged in the appliance		N/A
	Three forms of construction covered: (IEC 60335-1/A1:2013)		--

IEC 60335-2-14			
Clause	Requirement + Test	Result - Remark	Verdict
	a) Appliance supplied directly from the supply mains or a renewable energy source, the battery charging circuitry and other supply unit circuitry incorporated within the appliance (IEC 60335-1/A1:2013)		N/A
	b) The part of the appliance incorporating the battery is supplied from the supply mains or a renewable energy source, via a detachable supply unit. The battery charging circuitry is incorporated within the part of the appliance containing the battery (IEC 60335-1/A1:2013)		N/A
	c) The part of the appliance incorporating the battery is supplied from the supply mains or a renewable energy source, via a detachable supply unit. The battery charging circuitry is incorporated within the detachable supply unit (IEC 60335-1/A1:2013)		N/A
3.1.9	Appliance operated under the following conditions:		--
	- the appliance, supplied by its fully charged battery, operated as specified in relevant part 2		N/A
	- the battery is charged, the battery being initially discharged to such an extent that the appliance cannot operate		N/A
	-if possible, the appliance is supplied from the supply mains through its battery charger, the battery being initially discharged to such an extent that the appliance cannot operate. The appliance is operated as specified in relevant part 2		N/A
	- if the appliance incorporates inductive coupling between two parts that are detachable from each other, the appliance is supplied from the supply mains with the detachable part removed		N/A
3.6.2	Part to be removed in order to discard the battery is not considered to be detachable		N/A
5.B.101	Appliances supplied from the supply mains tested as specified for motor-operated appliances		N/A
7.1	Battery compartment for batteries intended to be replaced by the user, marked with battery voltage and polarity of the terminals		N/A
	The positive terminal indicated by symbol IEC 60417-5005 and the negative terminal by symbol IEC 60417-5006		N/A

IEC 60335-2-14			
Clause	Requirement + Test	Result - Remark	Verdict
	Appliances intending to be supplied from a detachable supply unit marked with symbol IEC 60417-6181 and its type reference along with symbol ISO 7000-0790 (2004-01), or (IEC 60335-1/A1:2013)		N/A
	use only with <model designation> supply unit (IEC 60335-1/A1:2013)		N/A
7.6	Symbols 60417-5005 and IEC 60417-5006		N/A
7.12	The instructions give information regarding charging		N/A
	The instructions for appliances incorporating batteries intended to be replaced by the user includes required information		N/A
	Details about how to remove batteries containing materials hazardous to the environment given		N/A
	For appliances intending to be supplied from a detachable supply unit for the purposes of recharging the battery, the type reference of the detachable supply unit is stated along with the following: (IEC 60335-1/A1:2013)		--
	WARNING: For the purposes of recharging the battery, only use the detachable supply unit provided with this appliance (IEC 60335-1/A1:2013)		N/A
	If the symbol for detachable supply unit is used, its meaning is explained (IEC 60335-1/A1:2013)		N/A
7.15	Markings placed on the part of the appliance connected to the supply mains		N/A
	The type reference of the detachable supply unit is placed in close proximity to the symbol (IEC 60335-1/A1:2013)		N/A
8.2	Appliances having batteries that according to the instruction may be replaced by the user need only have basic insulation between live parts and the inner surface of the battery compartment		N/A
	If the appliance can be operated without batteries, double or reinforced insulation required		N/A
11.7	The battery is charged for the period stated in the instructions or 24 h.....		N/A
11.8	Temperature rise of the battery surface does not exceed the limit in the battery manufacturer's specification; measured (K); limit (K) (IEC 60335-1/A1:2013)		N/A
	If no limit specified, the temperature rise does not exceed 20 K; measured (K) (IEC 60335-1/A1:2013)		N/A

IEC 60335-2-14			
Clause	Requirement + Test	Result - Remark	Verdict
19.1	Appliances subjected to tests of 19.B.101, 19.B.102 and 19.B.103		N/A
19.10	Not applicable		N/A
19.B.101	Appliances supplied at rated voltage for 168 h, the battery being continually charged		N/A
19.B.102	For appliances having batteries that can be removed without the aid of a tool, short-circuit of the terminals of the battery, the battery being fully charged,		N/A
19.B.103	Appliances having batteries replaceable by the user supplied at rated voltage under normal operation with the battery removed or in any position allowed by the construction		N/A
19.13	The battery does not rupture or ignite (IEC 60335-1/A1:2013)		N/A
21.B.101	Appliances having pins for insertion into socket-outlets have adequate mechanical strength		N/A
	Part of the appliance incorporating the pins subjected to the free fall test, procedure 2, of IEC 60068-2-31, the number of falls being:		--
	- 100, if the mass of the part does not exceed 250 g (g).....:		N/A
	- 50, if the mass of the part exceeds 250 g		N/A
	After the test, the requirements of 8.1, 15.1.1, 16.3 and clause 29 are met		N/A
22.3	Appliances having pins for insertion into socket-outlets tested as fully assembled as possible		N/A
25.13	An additional lining or bushing not required for interconnection cords in class III appliances or class III constructions operating at safety extra-low voltage not containing live parts		N/A
30.2	For parts of the appliance connected to the supply mains during the charging period, 30.2.3 applies		N/A
	For other parts, 30.2.2 applies		N/A
C	ANNEX C (NORMATIVE) AGEING TEST ON MOTORS		--
	The value of p in Table C.1 is 2 000, (IEC 60335-2-14)		N/A
	except for the following appliances for which it is 500: bean slicers, blenders, can openers, cheese graters, citrus-fruit squeezers, graters, ice-cream machines for use in refrigerators and freezers, knife sharpeners, knives, sieving machines, shredders. (IEC 60335-2-14)		N/A

IEC 60335-2-14			
Clause	Requirement + Test	Result - Remark	Verdict
D	ANNEX D (NORMATIVE) THERMAL MOTOR PROTECTORS		--
	Applicable to appliances having motors that incorporate thermal motor protectors necessary for compliance with the standard		N/A
	Test conditions as specified		N/A
E	ANNEX E (NORMATIVE) NEEDLE-FLAME TEST		--
	Needle-flame test carried out in accordance with IEC 60695-11-5, with the following modifications:		--
7	Severities		--
	The duration of application of the test flame is 30 s ± 1 s		P
9	Test procedure		--
9.1	The specimen so arranged that the flame can be applied to a vertical or horizontal edge as shown in the examples of Figure 1		P
9.2	The first paragraph does not apply		P
	If possible, the flame is applied at least 10 mm from a corner		P
9.3	The test is carried out on one specimen		P
	If the specimen does not withstand the test, the test may be repeated on two additional specimens, both withstanding the test		N/A
11	Evaluation of test results		--
	The duration of burning not exceeding 30 s		N/A
	However, for printed circuit boards, the duration of burning not exceeding 15 s		P
F	ANNEX F (NORMATIVE) CAPACITORS		--
	Capacitors likely to be permanently subjected to the supply voltage, and used for radio interference suppression or voltage dividing, comply with the following clauses of IEC 60384-14, with the following modifications:		--
1.5	Terms and definitions		--
1.5.3	Class X capacitors tested according to subclass X2		N/A
1.5.4	This subclause is applicable		N/A
1.6	Marking		--
	Items a) and b) are applicable		N/A
3.4	Approval testing		--

IEC 60335-2-14			
Clause	Requirement + Test	Result - Remark	Verdict
3.4.3.2	Table 3 is applicable as described		N/A
4.1	Visual examination and check of dimensions		--
	This subclause is applicable		N/A
4.2	Electrical tests		--
4.2.1	This subclause is applicable		N/A
4.2.5	This subclause is applicable		N/A
4.2.5.2	Only table 11 is applicable		N/A
	Values for test A apply		N/A
	However, for capacitors in heating appliances the values for test B or C apply		N/A
4.12	Damp heat, steady state		--
	This subclause is applicable		N/A
	Only insulation resistance and voltage proof are checked		N/A
4.13	Impulse voltage		--
	This subclause is applicable		N/A
4.14	Endurance		--
	Subclauses 4.14.1, 4.14.3, 4.14.4 and 4.14.7 are applicable		N/A
4.14.7	Only insulation resistance and voltage proof are checked		N/A
	No visible damage		N/A
4.17	Passive flammability test		--
	This subclause is applicable		N/A
4.18	Active flammability test		--
	This subclause is applicable		N/A
G	ANNEX G (NORMATIVE) SAFETY ISOLATING TRANSFORMERS		--
	The following modifications to this standard are applicable for safety isolating transformers:		--
7	Marking and instructions		--
7.1	Transformers for specific use marked with:		--
	-name, trademark or identification mark of the manufacturer or responsible vendor		N/A
	-model or type reference.....		N/A
17	Overload protection of transformers and associated circuits		--

IEC 60335-2-14			
Clause	Requirement + Test	Result - Remark	Verdict
	Fail-safe transformers comply with subclause 15.5 of IEC 61558-1		N/A
22	Construction		--
	Subclauses 19.1 and 19.1.2 of IEC 61558-2-6 are applicable		N/A
29	Clearances, creepage distances and solid insulation		--
29.1, 29.2, 29.3	The distances specified in items 2a, 2c and 3 in table 13 of IEC 61558-1 apply		N/A
	For insulated winding wires complying with subclause 19.12.3 of IEC 61558-1 there are no requirements for clearances or creepage distances		N/A
	For windings providing reinforced insulation, the distance specified in item 2c of table 13 of IEC 61558-1 is not assessed		N/A
	For safety isolating transformers subjected to periodic voltages with a frequency exceeding 30 kHz, the clearances, creepage distances and solid insulation values specified in IEC 60664-4 are applicable, if greater than the values specified in items 2a, 2c and 3 in table 13 of IEC 61558-1		N/A
H	ANNEX H (NORMATIVE) SWITCHES		--
	Switches comply with the following clauses of IEC 61058-1, as modified below:		--
	The tests of IEC 61058-1 carried out under the conditions occurring in the appliance		N/A
	Before being tested, switches are operated 20 times without load		N/A
8	Marking and documentation		--
	Switches are not required to be marked		N/A
	However, a switch that can be tested separately from the appliance marked with the manufacturer's name or trade mark and the type reference		N/A
13	Mechanism		--
	The tests may be carried out on a separate sample		N/A
15	Insulation resistance and dielectric strength		--
15.1	Not applicable		N/A
15.2	Not applicable		N/A
15.3	Applicable for full disconnection and micro-disconnection		N/A
17	Endurance		--

IEC 60335-2-14			
Clause	Requirement + Test	Result - Remark	Verdict
	Compliance is checked on three separate appliances or switches		N/A
	For 17.2.4.4, the number of cycles declared according to 7.1.4 is 10 000, unless		N/A
	otherwise specified in 24.1.3 of the relevant part 2 of IEC 60335		N/A
	Switches for operation under no load and which can be operated only by a tool, and		N/A
	switches operated by hand that are interlocked so that they cannot be operated under load,		N/A
	are not subjected to the tests		N/A
	However, switches without this interlock are subjected to the test of 17.2.4.4 for 100 cycles of operation		N/A
	Subclauses 17.2.2 and 17.2.5.2 not applicable		N/A
	The ambient temperature during the test is that occurring in the appliance during the test of Clause 11 in IEC 60335-1		N/A
	The temperature rise of the terminals not more than 30 K above the temperature rise measured in clause 11 of IEC 60335-1 (K)		N/A
20	Clearances, creepage distances, solid insulation and coatings of rigid printed board assemblies		--
	Clause 20 is applicable to clearances across full disconnection and micro-disconnection (IEC 60335-1/A1:2013)		N/A
	It is also applicable to creepage distances for functional insulation, across full disconnection and micro-disconnection, as stated in Table 24 (IEC 60335-1/A1:2013)		N/A
I	ANNEX I (NORMATIVE) MOTORS HAVING BASIC INSULATION THAT IS INADEQUATE FOR THE RATED VOLTAGE OF THE APPLIANCE		--
	The following modifications to this standard are applicable for motors having basic insulation that is inadequate for the rated voltage of the appliance:		--
8	Protection against access to live parts		--
8.1	Metal parts of the motor are considered to be bare live parts		N/A
11	Heating		--
11.3	The temperature rise of the body of the motor is determined instead of the temperature rise of the windings		N/A

IEC 60335-2-14			
Clause	Requirement + Test	Result - Remark	Verdict
11.8	The temperature rise of the body of the motor, where in contact with insulating material, not exceeding values in table 3 for the relevant insulating material		N/A
16	Leakage current and electric strength		--
16.3	Insulation between live parts of the motor and its other metal parts is not subjected to the test		N/A
19	Abnormal operation		--
19.1	The tests of 19.7 to 19.9 are not carried out		N/A
19.1.101	Appliance operated at rated voltage with each of the following fault conditions:		--
	- short circuit of the terminals of the motor, including any capacitor incorporated in the motor circuit		N/A
	- short circuit of each diode of the rectifier		N/A
	- open circuit of the supply to the motor		N/A
	- open circuit of any parallel resistor, the motor being in operation		N/A
	Only one fault simulated at a time, the tests carried out consecutively		N/A
22	Construction		--
22.1.101	For class I appliances incorporating a motor supplied by a rectifier circuit, the d.c. circuit being insulated from accessible parts of the appliance by double or reinforced insulation		N/A
	Compliance checked by the tests specified for double and reinforced insulation		N/A
J	ANNEX J (NORMATIVE) COATED PRINTED CIRCUIT BOARDS		--
	Testing of protective coatings of printed circuit boards carried out in accordance with IEC 60664-3 with the following modifications:		--
5.7	Conditioning of the test specimens		--
	When production samples are used, three samples of the printed circuit board are tested		N/A
5.7.1	Cold		--
	The test is carried out at -25 °C		N/A
5.7.3	Rapid change of temperature		--
	Severity 1 is specified		N/A
5.9	Additional tests		--
	This subclause is not applicable		N/A

IEC 60335-2-14			
Clause	Requirement + Test	Result - Remark	Verdict
K	ANNEX K (NORMATIVE) OVERVOLTAGE CATEGORIES		--
	The information on overvoltage categories is extracted from IEC 60664-1		P
	Overvoltage category is a numeral defining a transient overvoltage condition		P
	Equipment of overvoltage category IV is for use at the origin of the installation		N/A
	Equipment of overvoltage category III is equipment in fixed installations and for cases where the reliability and the availability of the equipment is subject to special requirements		N/A
	Equipment of overvoltage category II is energy consuming equipment to be supplied from the fixed installation		P
	If such equipment is subjected to special requirements with regard to reliability and availability, overvoltage category III applies		N/A
	Equipment of overvoltage category I is equipment for connection to circuits in which measures are taken to limit transient overvoltages to an appropriate low level		N/A
L	ANNEX L (INFORMATIVE) GUIDANCE FOR THE MEASUREMENT OF CLEARANCES AND CREEPAGE DISTANCES		--
	Information for the determination of clearances and creepage distances		P
M	ANNEX M (NORMATIVE) POLLUTION DEGREE		--
	The information on pollution degrees is extracted from IEC 60664-1		P
	Pollution		--
	The microenvironment determines the effect of pollution on the insulation, taking into account the macroenvironment		P
	Means may be provided to reduce pollution at the insulation by effective enclosures or similar		P
	Minimum clearances specified where pollution may be present in the microenvironment		P
	Degrees of pollution in the microenvironment		--
	For evaluating creepage distances, the following degrees of pollution in the microenvironment are established:		--

IEC 60335-2-14			
Clause	Requirement + Test	Result - Remark	Verdict
	- pollution degree 1: no pollution or only dry, non-conductive pollution occurs. The pollution has no influence		N/A
	- pollution degree 2: only non-conductive pollution occurs, except that occasionally a temporary conductivity caused by condensation is to be expected		N/A
	- pollution degree 3: conductive pollution occurs or dry non-conductive pollution occurs that becomes conductive due to condensation that is to be expected		P
	- pollution degree 4: the pollution generates persistent conductivity caused by conductive dust or by rain or snow		N/A
N	ANNEX N (NORMATIVE) PROOF TRACKING TEST		--
	The proof tracking test is carried out in accordance with IEC 60112 with the following modifications:		--
7	Test apparatus		--
7.3	Test solutions		--
	Test solution A is used		P
10	Determination of proof tracking index (PTI)		--
10.1	Procedure		--
	The proof voltage is 100V, 175V, 400V or 600V ...:	175 V: Plastic enclosure, Rotary switch, Interlock switch, motor brush holder, PCB	P
	The test is carried out on five specimens		P
	In case of doubt, additional test with proof voltage reduced by 25V, the number of drops increased to 100		N/A
10.2	Report		--
	The report states if the PTI value was based on a test using 100 drops with a test voltage of (PTI-25) V		N/A
O	ANNEX O (INFORMATIVE) SELECTION AND SEQUENCE OF THE TESTS OF CLAUSE 30		--
	Description of tests for determination of resistance to heat and fire		P
P	ANNEX P (INFORMATIVE) GUIDANCE FOR THE APPLICATION OF THIS STANDARD TO APPLIANCES USED IN WARM DAMP EQUABLE CLIMATES		--

IEC 60335-2-14			
Clause	Requirement + Test	Result - Remark	Verdict
	Modifications applicable for class 0 and 01 appliances having a rated voltage exceeding 150V, intended to be used in countries having a warm damp equable climate and that are marked WDaE		--
	Modifications may also be applied to class 1 appliances having a rated voltage exceeding 150V, intended to be used in countries having a warm damp equable climate and that are marked WdaE, if liable to be connected to a supply mains that excludes the protective earthing conductor		--
5.7	The ambient temperature for the tests of clauses 11 and 13 is 40 +3/0 °C		N/A
7.1	The appliance marked with the letters WDaE		N/A
7.12	The instructions state that the appliance is to be supplied through a residual current device (RCD) having a rated residual operating current not exceeding 30 mA		N/A
	The instructions state that the appliance is considered to be suitable for use in countries having a warm damp equable climate, but may also be used in other countries		N/A
11.8	The values of Table 3 are reduced by 15 K		N/A
13.2	The leakage current for class I appliances not exceeding 0,5 mA		N/A
15.3	The value of t is 37 °C		N/A
16.2	The leakage current for class I appliances not exceeding 0,5 mA (mA):		N/A
19.13	The leakage current test of 16.2 is applied in addition to the electric strength test of 16.3		N/A
Q	ANNEX Q (INFORMATIVE) SEQUENCE OF TESTS FOR THE EVALUATION OF ELECTRONIC CIRCUITS		--
	Description of tests for appliances incorporating electronic circuits		P
R	ANNEX R (NORMATIVE) SOFTWARE EVALUATION		--
	Programmable electronic circuits requiring software incorporating measures to control the fault/error conditions specified in table R.1 or R.2 validated in accordance with the requirements of this annex		N/A
R.1	Programmable electronic circuits using software		--
	Programmable electronic circuits requiring software incorporating measures to control the fault/error conditions specified in table R.1 or R.2 constructed so that the software does not impair compliance with the requirements of this standard		N/A
R.2	Requirements for the architecture		--

IEC 60335-2-14			
Clause	Requirement + Test	Result - Remark	Verdict
	Programmable electronic circuits requiring software incorporating measures to control the fault/error conditions specified in table R.1 or R.2 use measures to control and avoid software-related faults/errors in safety-related data and safety-related segments of the software		N/A
R.2.1.1	Programmable electronic circuits requiring software incorporating measures to control the fault/error conditions specified in table R.2 have one of the following structures:		--
	- single channel with periodic self-test and monitoring		N/A
	- dual channel (homogenous) with comparison		N/A
	- dual channel (diverse) with comparison		N/A
	Programmable electronic circuits requiring software incorporating measures to control the fault/error conditions specified in table R.1 have one of the following structures:		--
	- single channel with functional test		N/A
	- single channel with periodic self-test		N/A
	- dual channel without comparison		N/A
R.2.2	Measures to control faults/errors		--
R.2.2.1	When redundant memory with comparison is provided on two areas of the same component, the data in one area is stored in a different format from that in the other area		N/A
R.2.2.2	Programmable electronic circuits with functions requiring software incorporating measures to control the fault/error conditions specified in table R.2 and that use dual channel structures with comparison, have additional fault/error detection means for any fault/errors not detected by the comparison		N/A
R.2.2.3	For programmable electronic circuits with functions requiring software incorporating measures to control the fault/error conditions specified in table R.1 or R.2, means are provided for the recognition and control of errors in transmissions to external safety-related data paths		N/A
R.2.2.4	For programmable electronic circuits with functions requiring software incorporating measures to control the fault/error conditions specified in table R.1 or R.2, the programmable electronic circuits incorporate measures to address the fault/errors in safety-related segments and data indicated in table R.1 and R.2 as appropriate		N/A

IEC 60335-2-14			
Clause	Requirement + Test	Result - Remark	Verdict
R.2.2.5	For programmable electronic circuits with functions requiring software incorporating measures to control the fault/error conditions specified in table R.1 or R.2, detection of a fault/error occur before compliance with clause 19 and 20.101 is impaired (IEC 60335-2-14)		N/A
R.2.2.6	The software is referenced to relevant parts of the operating sequence and the associated hardware functions		N/A
R.2.2.7	Labels used for memory locations are unique		N/A
R.2.2.8	The software is protected from user alteration of safety-related segments and data		N/A
R.2.2.9	Software and safety-related hardware under its control is initialized and terminates before compliance with clause 19 and 20.101 is impaired (IEC 60335-2-14)		N/A
R.3	Measures to avoid errors		--
R.3.1	General		--
	For programmable electronic circuits with functions requiring software incorporating measures to control the fault/error conditions specified in table R.1 or R.2, the following measures to avoid systematic fault in the software are applied		--
	Software that incorporates measures used to control the fault/error conditions specified in table R.2 is inherently acceptable for software required to control the fault/error conditions specified in table R.1		N/A
R.3.2	Specification		--
R.3.2.1	Software safety requirements:	Software Id:	N/A
	The specification of the software safety requirements includes the descriptions listed		N/A
R.3.2.2	Software architecture		--
R.3.2.2.1	The specification of the software architecture includes the aspects listed <ul style="list-style-type: none"> - techniques and measures to control software faults/errors (refer to R.2.2); - interactions between hardware and software; - partitioning into modules and their allocation to the specified safety functions; - hierarchy and call structure of the modules (control flow); - interrupt handling; - data flow and restrictions on data access; - architecture and storage of data; - time-based dependencies of sequences and data 	Document ref. No:	N/A

IEC 60335-2-14			
Clause	Requirement + Test	Result - Remark	Verdict
R.3.2.2.2	The architecture specification is validated against the specification of the software safety requirements by static analysis		N/A
R.3.2.3	Module design and coding		--
R.3.2.3.1	Based on the architecture design, software is suitably refined into modules		N/A
	Software module design and coding is implemented in a way that is traceable to the software architecture and requirements		N/A
R.3.2.3.2	Software code is structured		N/A
R.3.2.3.3	Coded software is validated against the module specification by static analysis		N/A
	The module specification is validated against the architecture specification by static analysis		N/A
R.3.3.3	Software validation		--
	The software is validated with reference to the requirements of the software safety requirements specification		N/A
	Compliance is checked by simulation of:		--
	- input signals present during normal operation		N/A
	- anticipated occurrences		N/A
	- undesired conditions requiring system action		N/A

TABLE R.1^e – GENERAL FAULT/ERROR CONDITIONS

Component ^a	Fault/error	Acceptable measures ^{b,c}	Definitions See IEC 60730-1	Verdict
1 Central processing unit (CPU)				--
1.1 Registers	Stuck at	Functional test, or periodic self-test using either: - static memory test, or - word protection with single bit redundancy	H.2.16.5 H.2.16.6 H.2.19.6 H.2.19.8.2	N/A
1.2 VOID				--
1.3 Programme counter	Stuck at	Functional test, or Periodic self-test, or Independent time-slot monitoring, or Logical monitoring of the programme sequence	H.2.16.5 H.2.16.6 H.2.18.10.4 H.2.18.10.2	N/A

IEC 60335-2-14				
Clause	Requirement + Test		Result - Remark	Verdict
2 Interrupt handling and execution	No interrupt or too frequent interrupt	Functional test, or time-slot monitoring	H.2.16.5 H.2.18.10.4	N/A
3 Clock	Wrong frequency (for quartz synchronized clock: harmonics/sub-harmonics only)	Frequency monitoring, or time slot monitoring	H.2.18.10.1 H.2.18.10.4	N/A
4 Memory				--
4.1 Invariable memory	All single bit faults	Periodic modified checksum, or multiple checksum, or word protection with single bit redundancy	H.2.19.3.1 H.2.19.3.2 H.2.19.8.2	N/A
4.2 Variable memory	DC fault	Periodic static memory test, or word protection with single bit redundancy	H.2.19.6 H.2.19.8.2	N/A
4.3 Addressing (relevant to variable and invariable memory)	Stuck at	Word protection with single bit redundancy including the address	H.2.19.8.2	N/A
5 Internal data path	Stuck at	Word protection with single bit redundancy	H.2.19.8.2	N/A
5.1 VOID				--
5.2 Addressing	Wrong address	Word protection with single bit redundancy including the address	H.2.19.8.2	N/A
6 External communication	Hamming distance 3	Word protection with multi-bit redundancy, or CRC – single work, or Transfer redundancy, or Protocol test	H.2.19.8.1 H.2.19.4.1 H.2.18.2.2 H.2.18.14	N/A
6.1 VOID				--
6.2 VOID				--

IEC 60335-2-14				
Clause	Requirement + Test		Result - Remark	Verdict
6.3 Timing	Wrong point in time Wrong sequence	Time-slot monitoring, or scheduled transmission Time-slot and logical monitoring, or Comparison of redundant communication channels by either: - reciprocal comparison - independent hardware comparator Logical monitoring, or time-slot monitoring, or Scheduled transmission	H.2.18.10.4 H.2.18.18 H.2.18.10.3 H.2.18.15 H.2.18.3 H.2.18.10.2 H.2.18.10.4 H.2.18.18	N/A
7 Input/output periphery	Fault conditions specified in 19.11.2	Plausibility check	H.2.18.13	N/A
7.1 VOID				--
7.2 Analog I/O				--
7.2.1 A/D and D/A-converter	Fault conditions specified in 19.11.2	Plausibility check	H.2.18.13	N/A
7.2.2 Analog multiplexer	Wrong addressing	Plausibility check	H.2.18.13	N/A
8 VOID				--
9 Custom chips ^d e.g. ASIC, GAL, gate array	Any output outside the static and dynamic functional specification	Periodic self-test	H.2.16.6	N/A
<p>NOTE A Stuck-at fault model denotes a fault model representing an open circuit or a non-varying signal level. A DC fault model denotes a stuck-at fault model incorporating short circuit between signal lines.</p> <p>^a For fault/error assessment, some components are divided into their sub-functions. ^b For each sub-function in the table, the Table R.2 measure will cover the software fault/error. ^c Where more than one measure is given for a sub-function, these are alternatives. ^d To be divided as necessary by the manufacturer into sub-functions. ^e Table R.1 is applied according to the requirements of R.1 to R.2.2.9 inclusive.</p>				
S	ANNEX S (NORMATIVE) BATTERY OPERATED APPLIANCES POWERED BY BATTERIES THAT ARE NON-RECHARGEABLE OR NOT RECHARGED IN THE APPLIANCE (IEC 60335-1/A1:2013)			--

IEC 60335-2-14			
Clause	Requirement + Test	Result - Remark	Verdict
	The following modifications to this standard are applicable for battery-operated appliances where the batteries are either non-rechargeable (primary batteries), or		N/A
	rechargeable batteries (secondary batteries) that are not recharged in the appliance		N/A
5.8.1	If the supply terminals for the connection of the battery have no indication of polarity, the more unfavourable polarity is applied		N/A
5.S.101	Appliances intended for use with a battery box are tested with the battery box supplied with the appliance or with the battery box recommended in the instructions		N/A
5.S.102	Appliances are tested as motor-operated appliances.		N/A
7.1	Appliances marked with the battery voltage (V) and the polarity of the terminals, unless		N/A
	the polarity is irrelevant		N/A
	Appliances also marked with:		--
	– name, trade mark or identification mark of the manufacturer or responsible vendor		N/A
	– model or type reference		N/A
	– IP number according to degree of protection against ingress of water, other than IPX0... ..		N/A
	– type reference of battery or batteries.....		N/A
	If relevant, the positive terminal is indicated by the symbol IEC 60417-5005 and the negative terminal by the symbol IEC 60417-5006		N/A
	If appliances use more than one battery, they are marked to indicate correct polarity connection of the batteries		N/A
7.6	Additional symbols		N/A
7.12	The instructions contain the following, as applicable:		--
	– the types of batteries that may be used... ..		N/A
	– how to remove and insert the batteries		N/A
	– non-rechargeable batteries are not to be recharged		N/A
	– rechargeable batteries are to be removed from the appliance before being charged		N/A
	– different types of batteries or new and used batteries are not to be mixed		N/A

IEC 60335-2-14			
Clause	Requirement + Test	Result - Remark	Verdict
	– batteries are to be inserted with the correct polarity		N/A
	– exhausted batteries are to be removed from the appliance and safely disposed of		N/A
	– if the appliance is to be stored unused for a long period, the batteries are removed		N/A
	– the supply terminals are not to be short-circuited		N/A
11.5	Appliances are supplied with the most unfavourable supply voltage between		--
	– 0,55 and 1,0 times the battery voltage, if the appliance can be used with non-rechargeable batteries		N/A
	– 0,75 and 1,0 times battery voltage, if the appliance is designed for use with rechargeable batteries only		N/A
	The values specified in Table S.101 for the internal resistance per cell of the battery is taken into account		N/A
19.1	The tests are carried out with the battery fully charged unless otherwise specified		N/A
19.13	The battery does not rupture or ignite		N/A
19.S.101	Appliances are supplied with the voltage specified in 11.5. The supply terminals having an indication of polarity are connected to the opposite polarity, unless		N/A
	such a connection is unlikely to occur due to the construction of the appliance		N/A
19.S.102	For appliances with provision for multiple batteries, one or more of the batteries are reversed and the appliance is operated, if reversal of batteries is allowed by the construction		N/A
25.5	The flexible leads or flexible cord used to connect an external battery or battery box in is connected to the appliance by a type X attachment		N/A
25.13	This requirement is not applicable to the flexible leads or flexible cord connecting external batteries or a battery box with an appliance		N/A
25.S.101	Appliances have suitable means for connection of the battery. If the type of battery is marked on the appliance, the means of connection is suitable for this type of battery		N/A
26.5	Terminal devices in an appliance for the connection of the flexible leads or flexible cord connecting an external battery or battery box are so located or shielded that there is no risk of accidental connection between supply terminals		N/A

IEC 60335-2-14			
Clause	Requirement + Test	Result - Remark	Verdict
30.2.3.2	There is no battery in the area of the vertical cylinder used for the consequential needle flame test, unless		N/A
	the battery is shielded by a barrier that meets the needle flame test of Annex E, or		N/A
	that comprises material classified as V-0 or V-1 according to IEC 60695-11-10		N/A

IEC 60335-2-14			
Clause	Requirement + Test	Result - Remark	Verdict

10.1	TABLE: Power input deviation					P
Input deviation of/at:	P rated (W)	P measured (W)	dP (W, %)	Required dP (W, %)	Remark	
230 V (50Hz)	500 W	410,1 W	-18,0 %	+15%	BT-B25B (Blender)	
230 V (60Hz)	500 W	399,3 W	-20,1 %	+15%		
230 V (50Hz)	500 W	291,6 W	-41,7 %	+15%	BT-B25B (Coffee mill)	
230 V (60Hz)	500 W	288,0 W	-42,4 %	+15%		
230 V (50Hz)	500 W	505,5 W	+1,1 %	+15%	BT-B15A (Blender)	
230 V (60Hz)	500 W	505,2 W	+1,0 %	+15%		
230 V (50Hz)	500 W	277,2 W	-44,6 %	+15%	BT-B15A (Coffee mill)	
230 V (60Hz)	500 W	270,0 W	-46,0 %	+15%		
230 V (50Hz)	500 W	419,7 W	-16,1 %	+15%	BT-B35B (Blender)	
230 V (60Hz)	500 W	420,3 W	-15,9 %	+15%		
230 V (50Hz)	500 W	295,2 W	-41,0 %	+15%	BT-B35B (Coffee mill)	
230 V (60Hz)	500 W	289,6 W	-42,1 %	+15%		
230 V (50Hz)	500 W	464,1 W	-7,2 %	+15%	BT-B32A (Blender)	
230 V (60Hz)	500 W	456,3 W	-8,7 %	+15%		
230 V (50Hz)	500 W	277,2 W	-44,6 %	+15%	BT-B32A (Coffee mill)	
230 V (60Hz)	500 W	270,4 W	-45,9 %	+15%		
Supplementary information:						

10.2	TABLE: Current deviation					N/A
Current deviation of/at:	I rated (A)	I measured (A)	dI (A, %)	Required dI (A, %)	Remark	
Supplementary information:						

11.7	Table : Normal operation					P
Test step	Load (ingredients)	quantity	Time of operation (on/off)	Number of operation	remark	
11.7.1	Carrort and water	Carrort: 600g water: 900g	On: 3 min Off: 1 min	10	Blender function refer to cl 11.7.1	

IEC 60335-2-14			
Clause	Requirement + Test	Result - Remark	Verdict
11.8-1	TABLE: Heating test, thermocouple measurements BT-B25B (blender)		P
	Test voltage (V)	1,06 x 240 = 254,4 V	—
	Ambient (°C)	t1: 23,1°C; t2: 23,1°C	—
Thermocouple locations	Max. temperature rise measured, dT (K)	Max. temperature rise limit, dT (K)	
Bifucation of power cord	38,9	50	
Power cord inside	37,2	50	
Motor winding	76,6	(class 120) 80	
Motor Bobbin	53,3	For clause 30.1	
Motor brush holder	52,6	For clause 30.1	
Silicone tube used for supplementary insulation	38,0	145	
Rotary switch	32,4	T85-25=60	
Interlock switch	37,0	T120-25=95	
Internal wire	49,9	T105-25=80	
The gear of motor shaft	31,0	For clause 30.1	
Plastic enclosure (inside)	36,3	For clause 30.1	
Plastic enclosure (outside)	13,6	65	
Metal enclosure (outside)	31,7	45	
Bottom enclosure(inside)	49,9	For clause 30.1	
Bottom enclosure(outside)	49,1	65	
Knob (inside)	5,3	For clause 30.1	
Knob (outside)	3,9	39	
Handle of lid (outside)	13,4	60 (or for clause 30.1)	
Handle of cup (outside)	12,3	60	
Test floor	40,4	65	
Test wall	1,5	65	
X2 capacitor	33,2	T100-25=75	
PCB	32,8	120	
Supplementary information:			

11.8-1	TABLE: Heating test, resistance method					P
	Test voltage (V)	1,06 x 240 = 254,4 V			—	
	Ambient, t1 (°C)	23,1°C			—	
	Ambient, t2 (°C)	23,1°C			—	
Temperature rise of winding	R1 (Ω)	R2 (Ω)	dT (K)	Max. dT (K)	Insulation class	
Motor winding	4,76	6,39	88,2	90	120	
Supplementary information:						

11.8-2	TABLE: Heating test, thermocouple measurements BT-B15A (blender)			P
	Test voltage (V)	1,06 x 240 = 254,4 V		—

IEC 60335-2-14			
Clause	Requirement + Test	Result - Remark	Verdict
	Ambient (°C).....	t1: 24,4°C; t2: 23,4°C	—
	Thermocouple locations	Max. temperature rise measured, dT (K)	Max. temperature rise limit, dT (K)
	Bifucation of power cord	23,4	50
	Power cord inside	24,0	50
	Motor winding	66,0	(class 120) 80
	Motor Bobbin	47,6	For clause 30.1
	Motor brush holder	51,0	For clause 30.1
	Silicone tube used for supplementary insulation	28,3	145
	Rotary switch	25,0	T85-25=60
	Interlock switch	32,8	T120-25=95
	Internal wire	30,5	T105-25=80
	The gear of motor shaft	29,8	For clause 30.1
	Plastic enclosure (inside)	31,5	For clause 30.1
	Plastic enclosure (outside)	11,1	65
	Metal enclosure (outside)	18,1	45
	Glass enclosure (outside)	17,8	60
	Bottom enclosure(inside)	41,9	For clause 30.1
	Bottom enclosure(outside)	40,9	65
	Knob (inside)	3,2	For clause 30.1
	Knob (outside)	1,5	39
	Handle of lid (outside)	8,7	60 (or for clause 30.1)
	Handle of cup (outside)	14,0	60
	Test floor	39,3	65
	Test wall	1,8	65
	X2 capacitor	22,9	T100-25=75
	PCB	22,3	120
Supplementary information:			

11.8-2	TABLE: Heating test, resistance method					P
	Test voltage (V)	1,06 x 240 = 254,4 V				—
	Ambient, t1 (°C).....	24,4°C				—
	Ambient, t2 (°C).....	23,4°C				—
	Temperature rise of winding	R1 (Ω)	R2 (Ω)	dT (K)	Max. dT (K)	Insulation class
	Motor winding	4,75	6,17	76,8	90	120
Supplementary information:						

11.8-3	TABLE: Heating test, thermocouple measurements BT-B35B (blender)					P
	Test voltage (V)	1,06 x 240 = 254,4 V				—
	Ambient (°C).....	t1: 23,2°C; t2: 22,2°C				—

IEC 60335-2-14			
Clause	Requirement + Test	Result - Remark	Verdict
Thermocouple locations	Max. temperature rise measured, dT (K)	Max. temperature rise limit, dT (K)	
Bifucation of power cord	24,5	50	
Power cord inside	24,9	50	
Motor winding	67,4	(class 120) 80	
Motor Bobbin	48,8	For clause 30.1	
Motor brush holder	51,2	For clause 30.1	
Silicone tube used for supplementary insulation	29,2	145	
Rotary switch	25,7	T85-25=60	
Interlock switch	33,6	T120-25=95	
Internal wire	31,3	T105-25=80	
The gear of motor shaft	30,7	For clause 30.1	
Plastic enclosure (inside)	32,2	For clause 30.1	
Plastic enclosure (outside)	11,5	65	
Glass enclosure (outside)	18,3	60	
Bottom enclosure(inside)	41,2	For clause 30.1	
Bottom enclosure(outside)	39,8	65	
Knob (inside)	4,2	For clause 30.1	
Knob (outside)	2,6	39	
Handle of lid (outside)	8,9	60 (or for clause 30.1)	
Handle of cup (outside)	14,7	60	
Test floor	39,3	65	
Test wall	2,7	65	
X2 capacitor	25,8	T100-25=75	
PCB	25,5	120	
Supplementary information:			

11.8-3	TABLE: Heating test, resistance method					P
	Test voltage (V)	1,06 x 240 = 254,4 V				—
	Ambient, t1 (°C)	23,2°C				—
	Ambient, t2 (°C)	22,2°C				—
Temperature rise of winding	R1 (Ω)	R2 (Ω)	dT (K)	Max. dT (K)	Insulation class	
Motor winding	4,77	6,19	76,43	90	120	
Supplementary information:						

11.8-4	TABLE: Heating test, thermocouple measurements BT-B32A (blender)					P
	Test voltage (V)	1,06 x 240 = 254,4 V				—
	Ambient (°C)	t1: 24,4°C; t2: 23,4°C				—
Thermocouple locations	Max. temperature rise measured, dT (K)	Max. temperature rise limit, dT (K)				
Bifucation of power cord	23,3	50				

IEC 60335-2-14			
Clause	Requirement + Test	Result - Remark	Verdict
	Power cord inside	23,7	50
	Motor winding	66,2	(class 120) 80
	Motor Bobbin	47,6	For clause 30.1
	Motor brush holder	50,0	For clause 30.1
	Silicone tube used for supplementary insulation	28,0	145
	Rotary switch	24,5	T85-25=60
	Interlock switch	32,4	T120-25=95
	Internal wire	30,1	T105-25=80
	The gear of motor shaft	29,5	For clause 30.1
	Plastic enclosure (inside)	31,0	For clause 30.1
	Plastic enclosure (outside)	10,3	65
	Glass enclosure (outside)	17,1	60
	Bottom enclosure(inside)	40,0	For clause 30.1
	Bottom enclosure(outside)	38,6	65
	Knob (inside)	3,0	For clause 30.1
	Knob (outside)	1,4	39
	Handle of lid (outside)	7,7	60 (or for clause 30.1)
	Handle of cup (outside)	13,5	60
	Test floor	38,1	65
	Test wall	1,5	65
	X2 capacitor	23,8	T100-25=75
	PCB	24,5	120
Supplementary information:			

11.8-4	TABLE: Heating test, resistance method					P
	Test voltage (V)	1,06 x 240 = 254,4 V				—
	Ambient, t1 (°C)	24,4°C				—
	Ambient, t2 (°C)	23,4°C				—
	Temperature rise of winding	R1 (Ω)	R2 (Ω)	dT (K)	Max. dT (K)	Insulation class
	Motor winding	4,77	6,18	75,9	90	120
Supplementary information:						

13.2	TABLE: Leakage current			P
	Heating appliances: 1.15 x rated input (W)	—		—
	Motor-operated and combined appliances: 1.06 x rated voltage (V)	1,06 x 240 = 254,4 V		—
	Leakage current between	I (mA)	Max. allowed I (mA)	
	Live part and accessible part	0,02	0,35 peak	
Supplementary information: --				

13.3	TABLE: Electric strength			P
------	--------------------------	--	--	---

IEC 60335-2-14			
Clause	Requirement + Test	Result - Remark	Verdict
Test voltage applied between:		Voltage (V)	Breakdown (Yes/No)
Live part and accessible part		3000	No
Supplementary information: --			

14	TABLE: Transient overvoltages					N/A
Clearance between:	CI (mm)	Required CI (mm)	Rated impulse voltage (V)	Impulse test voltage (V)	Flashover (Yes/No)	
Supplementary information: --						

16.2	TABLE: Leakage current			P
	Single phase appliances: 1.06 x rated voltage (V)	1,06 x 240 = 254,4 V		—
	Three phase appliances 1.06 x rated voltage divided by $\sqrt{3}$ (V).....	—		—
Leakage current between		I (mA)	Max. allowed I (mA)	
Live part and accessible part		0,04	0,25 r.m.s.	
Supplementary information: --				

16.3	TABLE: Electric strength			P
Test voltage applied between:		Voltage (V)	Breakdown (Yes/No)	
Live part and accessible part		3000	No	
Supplementary information: --				

17	TABLE: Overload protection, thermocouple measurements			N/A
Temperature rise of part/at:		dT (K)	Max. dT (K)	
Supplementary information:				

17	TABLE: Overload protection, resistance method					N/A
	Test voltage (V)					—
	Ambient, t1 (°C).....					—
	Ambient, t2 (°C).....					—
Temperature of winding	R1 (Ω)	R2 (Ω)	dT (K)	T (°C)	Max. T (°C)	

IEC 60335-2-14			
Clause	Requirement + Test	Result - Remark	Verdict
Supplementary information:			

19	Abnormal operation conditions						P
Operational characteristics	YES/NO	Operational conditions					
Are there electronic circuits to control the appliance operation?	Yes	—					
Are there “off” or “stand-by” position?	Yes	—					
The unintended operation of the appliance results in dangerous malfunction?	No	—					
Sub-clause	Operating conditions description	Test results description	PEC description	EMP 19.11.4	Software type required	19.11.3 PEC	Final result
19.2	—	—	—	—	—	—	N/A
19.3	—	—	—	—	—	—	N/A
19.4	—	—	—	—	—	—	N/A
19.5	—	—	—	—	—	—	N/A
19.6	—	—	—	—	—	—	N/A
19.7	Lock the moving part of motor	No hazard	—	—	—	—	P
19.8	—	—	—	—	—	—	N/A
19.9	—	—	—	—	—	—	N/A
19.10	1,3 times rated vltage for 1 min	parts didn't eject from the appliance	—	—	—	—	P
19.11.2	Fault conditions a) to g) specified in 19.11.2 are not applied to circuits	No hazard	—	—	—	—	P
19.11.4.8	—	—	—	—	—	—	N/A

IEC 60335-2-14							
Clause	Requirement + Test			Result - Remark			Verdict
19.101	<i>Coffee mills and grain grinders are supplied at rated voltage and operated under normal operation five times with rest periods.</i>	No hazard	—	—	—	—	P
19.102	<i>Coffee mills are filled with 40 g of coffee beans to which are added two granite chips that pass through an 8 mm screen but not a 7 mm screen</i>	Motor did not stall	—	—	—	—	P
Supplementary information:							

19.7	TABLE: Abnormal operation, locked rotor/moving parts						P
	Test voltage (V)						—
	Ambient, t1 (°C)						—
	Ambient, t2 (°C)						—
Temperature of winding		R1 (Ω)	R2 (Ω)	dT (K)	T (°C)	Max. T (°C)	
Supplementary information: the test data see table 19.13.							

19.9	TABLE: Abnormal operation, running overload						N/A
	Test voltage (V)						—
	Ambient, t1 (°C)						—

IEC 60335-2-14						
Clause	Requirement + Test			Result - Remark		Verdict
	Ambient, t2 (°C).....					—
Temperature of winding	R1 (Ω)	R2 (Ω)	dT (K)	T (°C)	Max. T (°C)	
Supplementary information:						

19.13	TABLE: Abnormal operation, temperature rises For model: BT-B25B (blender)				P
Thermocouple locations	Max. temperature rise measured, dT (K)			Max. temperature rise limit, dT (K)	
	19.7	19.101	19.102		
Bifucation of power cord	1,6	19,0	4,7	150	
Power cord inside	12,1	18,9	4,6	150	
Motor winding	126,9°C	53,1°C	35,8°C	(class 120) 215°C	
Mortor bobbin	27,0	22,5	7,1	For clause 30.1	
The gear of motor shaft	21,1	17,4	5,5	For clause 30.1	
Plastic enclosure (inside)	23,0	20,9	6,1	For clause 30.1	
Bottom enclosure(inside)	5,0	26,0	9,4	For clause 30.1	
Knob (inside)	1,2	3,2	0,6	For clause 30.1	
Test floor	1,5	22,1	6,5	150	
Test wall	1,0	1,6	1,1	150	
Supplementary information:					

24.1	TABLE: Components information				P
Object / part No.	Manufacturer/ trademark	Type / model	Technical data	Standard	Mark(s) of conformity ¹⁾
Plug	JIANGMEN GOMENTECH ELECTRICAL CO., LTD.	GM-02	AC 250 V; 2,5 A	DIN VDE 0620-1 IEC 60884-1:2013	VDE 40022512
(Alternative)	Zhongshan Nantou Hongyun Electric Appliance Accessories Factory	HY-008	AC 250 V; 2,5 A	DIN VDE 0620-1; IEC 60884-1:2013	VDE 40032414
(Alternative)	JIANGMEN GOMENTECH ELECTRICAL CO., LTD.	GM-01	AC 250 V; 16 A	DIN VDE 0620-1; IEC 60884-1:2013	VDE 40023785

IEC 60335-2-14					
Clause	Requirement + Test			Result - Remark	Verdict
(Alternative)	Hong Shan Chuan Industry (Shen Zhen) Co., Ltd.	HSC-402, HSC-403	AC 250 V; 16 A	DIN VDE 0620-1; IEC 60884-1:2013	VDE 40021749
(Alternative)	Guangdong Yincheng Electric Appliance Co.Ltd	YC-S2.5	AC 250 V; 2,5 A	DIN VDE 0620; IEC 60884-1:2013	VDE 40025273
(Alternative)	Zhongshan Guzhen Hongli Cable & Appliance Factory	HL-6	AC 250 V; 2,5 A	DIN VDE 0620-1; IEC 60884-1:2013	VDE 40009738
(Alternative)	Zhongshan Guzhen Hongli Cable & Appliance Factory	HL-9	AC 250 V; 16A	DIN VDE 0620-1; IEC 60884-1:2013	VDE 40013791
BS Plug	Luen Tai (IP'S) Electrical Mfy	8191, 9691, 9248, 9518	AC 250 V; 13 A	BS 1363-1 IEC 60884-1:2013	KM 40790
(Alternative)	Dongguan Ubill Electrical Co.,Ltd	UBL 8008 & AP-411A	AC 250 V; 13 A	BS 1363-1 IEC 60884-1:2013	ASTA 1183
(Alternative)	Zhongshan Guzhen Hongli Cable & Appliance Factory	HL-17	AC 250 V; 13 A	BS 1363-1 IEC 60884-1:2013	ASTA 882
SASO Plug	De Chang Electronic Manufactory	DC-168A	AC 250 V; 13 A	SASO 2203 IEC 60884-1:2013	Intertek Report No.: GZ1312050 61GZU-001
(Alternative)	Zhongshan Guzhen Hongli Cable & Appliance Factory	HL-17	AC 250 V; 13 A	SASO 2203 IEC 60884-1:2013	KSA R 310205/3
Power cord	JIANGMEN GOMENTECH ELECTRICAL CO., LTD.	H05VVH2-F 60227 IEC 53	2x0,75 mm ²	EN 50525-2-11 IEC 60227-5:2011	VDE 40018946
(Alternative)	Hong Shan Chuan Industry (Shen Zhen) Co., Ltd.	H05VVH2-F 60227 IEC 53	2x0,75 mm ²	EN 50525-2-11 IEC 60227-5:2011	VDE 40037206
(Alternative)	Guangdong Yincheng Electric Appliance Co.Ltd	H05VVH2-F 60227IEC 53	2x0,75 mm ²	EN 50525-2-11 IEC 60227-5:2011	VDE 40018525
(Alternative)	Zhongshan Guzhen Hongli Cable & Appliance Factory	H05VVH2-F 60227IEC 53	2x0,75 mm ²	EN 50525-2-11 IEC 60227-5:2011	VDE 139259

IEC 60335-2-14					
Clause	Requirement + Test			Result - Remark	Verdict
Rotary switch (2 speed) (for model: BT-B02A, BT- B02B, BT-B12A, BT-B12B, BT- B22A, BT-B22B, BT-B32A, BT- B32B)	Sha Tou Chang Hardware Electrical Appliance Factory	CJ-102	250 V; 3A; T85; 1E4; GWT850°C	EN 61058-1 IEC 61058-1: 2000	TUV SUD B 09 01 39547 003
Rotary switch (5 speed) (for model: BT-B05A, BT- B05B, BT-B15A, BT-B15B, BT- B25A, BT-B25B, BT-B35A, BT- B35B)	Legion Electronic Co., Ltd	MFR01	AC 250 V; 12A- 8(3)A; T125; 1E4; GWT850°C	EN 61058-1 IEC 61058-1: 2000	NEMKO NO56963/A 1
Interlock switch	Guangzhou Taiheng Electric Appliance Co., Ltd.	THW-3, THW- 16	AC 250 V; 5A; 5E4; T120;	EN 61058-1 IEC 61058-1: 2000	TUV R50200051
(Alternative)	Yueqing Tianma Electric Co.,Ltd	KW4A(S)	AC 250 V, 5(2) A, T125, 5E4	EN 61058-1 IEC 61058-1: 2000	TUV R50299225
Motor	Jiangmen City Jianghai District Junhui Electric Manufacture Co.,Ltd	HC7630	AC 220 – 240 V; 50/60 Hz; 500W; class120;	EN 60335-2-14 IEC 60335-2-14: 2016 EN 60335-1 IEC 60335- 1:2010+A1+A2	Tested with appliance
Internal wire	HESHAN CITY TEHSING HUANCHIU ELECTRIC CABLE CO LTD	1015	18-22AWG; 105°C; 600V;	EN 60335-2-14 IEC 60335-2-14: 2016 EN 60335-1 IEC 60335- 1:2010+A1+A2	Tested with appliance UL E229340
(Alternative)	ZHONG SHAN YONG ROI ELECTRIC FACTORY CO LTD	1015	18-22AWG; 105°C; 600V;	EN 60335-2-14 IEC 60335-2-14: 2016 EN 60335-1 IEC 60335- 1:2010+A1+A2	Tested with appliance UL E204893
(Alternative)	SHUNDE JIANJIN WIRE CO LTD	1015	18-22AWG; 105°C; 600V;	EN 60335-2-14 IEC 60335-2-14: 2016 EN 60335-1 IEC 60335- 1:2010+A1+A2	Tested with appliance UL E464548

IEC 60335-2-14					
Clause	Requirement + Test			Result - Remark	Verdict
(Alternative)	SHENZHEN DONG JU WIRE & CABLE CO LTD	1015	18-22AWG; 105°C; 600V;	EN 60335-2-14 IEC 60335-2-14: 2016 EN 60335-1 IEC 60335-1: 2010+A1+A2	Tested with appliance UL E189674
(Alternative)	3F ELECTRONICS INDUSTRY CORP	3135	200°C; 300V; 16- 24AWG	EN 60335-2-14 IEC 60335-2-14: 2016 EN 60335-1 IEC 60335-1: 2010+A1+A2	Tested with appliance UL E211048
(Alternative)	Jiangsu Naian Special Cable & Wire Co Ltd	3122	200°C; 300V; 16- 24AWG;	EN 60335-2-14 IEC 60335-2-14: 2016 EN 60335-1 IEC 60335-1: 2010+A1+A2	Tested with appliance UL E217633
(Alternative)	FOSHAN SHUNDE PANTAI SPECIAL WIRE ROD ELECTRONICS CO LTD	3122	200°C; 300V; 16- 24AWG;	EN 60335-2-14 IEC 60335-2-14: 2016 EN 60335-1 IEC 60335-1: 2010+A1+A2	Tested with appliance UL E346532
(Alternative)	Zhuhai Hengwang Electronics Co Ltd	3122	200°C; 300V; 16- 24AWG;	EN 60335-2-14 IEC 60335-2-14: 2016 EN 60335-1 IEC 60335-1: 2010+A1+A2	Tested with appliance UL E314186
(Alternative)	Shenzhen Mysun Insulation Materials Co Ltd	3122	200°C; 300V; 16- 24AWG;	EN 60335-2-14 IEC 60335-2-14: 2016 EN 60335-1 IEC 60335-1: 2010+A1+A2	Tested with appliance UL E239689
(Alternative)	Zhongshan Sen Te Wire & Cable Co Ltd	3122	200°C; 300V; 16- 24AWG;	EN 60335-2-14 IEC 60335-2-14: 2016 EN 60335-1 IEC 60335-1: 2010+A1+A2	Tested with appliance UL E315793
(Alternative)	Power Act Enterprises Ltd	3122	200°C; 300V; 16- 24AWG;	EN 60335-2-14 IEC 60335-2-14: 2016 EN 60335-1 IEC 60335-1: 2010+A1+A2	Tested with appliance UL E310829
(Alternative)	Jiangyin Yuanda Electrical Material Co Ltd	3122	200°C; 300V; 16- 24AWG;	EN 60335-2-14 IEC 60335-2-14: 2016 EN 60335-1 IEC 60335-1: 2010+A1+A2	Tested with appliance UL E216252

IEC 60335-2-14					
Clause	Requirement + Test	Result - Remark		Verdict	
(Alternative)	Kelin Wire Co Ltd (Dongguan)	3122	200°C; 300V; 16-24AWG;	EN 60335-2-14 IEC 60335-2-14: 2016 EN 60335-1 IEC 60335-1:2010+A1+A2	Tested with appliance UL E250866
(Alternative)	Guangzhou Fengtai Meihua Cable Co Ltd	3122	200°C; 300V; 16-24AWG;	EN 60335-2-14 IEC 60335-2-14: 2016 EN 60335-1 IEC 60335-1:2010+A1+A2	Tested with appliance UL E204798
(Alternative)	Zhongshan City Dingxiang Electrical Co Ltd	3122	200°C; 300V; 16-24AWG;	EN 60335-2-14 IEC 60335-2-14: 2016 EN 60335-1 IEC 60335-1:2010+A1+A2	Tested with appliance UL E354487
(Alternative)	Jiangyin City Tiancheng Electronic & Cable Co Ltd	3122	200°C; 300V; 16-24AWG;	EN 60335-2-14 IEC 60335-2-14: 2016 EN 60335-1 IEC 60335-1:2010+A1+A2	Tested with appliance UL E332921
(Alternative)	Dong Guan Sheng Pai Electric Wire & Cable Co Ltd	3122	200°C; 300V; 16-24AWG;	EN 60335-2-14 IEC 60335-2-14: 2016 EN 60335-1 IEC 60335-1:2010+A1+A2	Tested with appliance UL E347603
(Alternative)	Wuxi Huacheng Cable Co Ltd	3122	200°C; 300V; 16-24AWG;	EN 60335-2-14 IEC 60335-2-14: 2016 EN 60335-1 IEC 60335-1:2010+A1+A2	Tested with appliance UL E206992
(Alternative)	Hong Shun Wire & Cable Fluoroplastics Factory	1332	200°C; 300V; 16-26AWG;	EN 60335-2-14 IEC 60335-2-14: 2016 EN 60335-1 IEC 60335-1:2010+A1+A2	Tested with appliance UL E238396
(Alternative)	Guangdong Zhongshan Yixin Electrical Co Ltd	1332	200°C; 300V; 16-26AWG;	EN 60335-2-14 IEC 60335-2-14: 2016 EN 60335-1 IEC 60335-1:2010+A1+A2	Tested with appliance UL E351034
(Alternative)	Qifurui Electronics Co	1332	200°C; 300V; 16-26AWG;	EN 60335-2-14 IEC 60335-2-14: 2016 EN 60335-1 IEC 60335-1:2010+A1+A2	Tested with appliance UL E211048

IEC 60335-2-14					
Clause	Requirement + Test			Result - Remark	Verdict
(Alternative)	Kelin Wire Co Ltd (Dongguan)	1332	200°C; 300V; 16-26AWG;	EN 60335-2-14 IEC 60335-2-14: 2016 EN 60335-1 IEC 60335-1:2010+A1+A2	Tested with appliance UL E250866
(Alternative)	Jiangyin Yuanda Electrical Material Co Ltd	1332	200°C; 300V; 16-26AWG;	EN 60335-2-14 IEC 60335-2-14: 2016 EN 60335-1 IEC 60335-1:2010+A1+A2	Tested with appliance UL E216252
(Alternative)	Zhuhai Hengwang Electronics Co Ltd	1332	200°C; 300V; 16-26AWG;	EN 60335-2-14 IEC 60335-2-14: 2016 EN 60335-1 IEC 60335-1:2010+A1+A2	Tested with appliance UL E314186
(Alternative)	Guangzhou Fengtai Meihua Cable Co Ltd	1332	200°C; 300V; 16-26AWG;	EN 60335-2-14 IEC 60335-2-14: 2016 EN 60335-1 IEC 60335-1:2010+A1+A2	Tested with appliance UL E204798
(Alternative)	Foshan City Zheng Guan Fluoroplastics Wire Factory	1332	200°C; 300V; 16-26AWG;	EN 60335-2-14 IEC 60335-2-14: 2016 EN 60335-1 IEC 60335-1:2010+A1+A2	Tested with appliance UL E307535
Rubber tube	SHENZHEN WAHCHANGWEI INDUSTRIAL CO LTD	SRS-70*	200°C, 600 V	EN 60335-2-14 IEC 60335-2-14: 2016 EN 60335-1 IEC 60335-1:2010+A1+A2	Tested with appliance UL E233803
Closed-end connector	HEAVY POWER Co.,Ltd.	CE2	150°C	EN 60335-2-14 IEC 60335-2-14: 2016 EN 60335-1 IEC 60335-1:2010+A1+A2	Tested with appliance UL E113650
Plastic enclosure	Tianjin Dagu chemical Limited by Share Ltd.	DG-417	ABS	EN 60335-2-14 IEC 60335-2-14: 2016 EN 60335-1 IEC 60335-1:2010+A1+A2	Tested with appliance UL E363596
X2 capacitor	Tenta Electric Industrial Co. Ltd.	MEX TENTA MKP	0,22uf; 275V; 40/100/21	EN 60384-14 IEC 60384-14: 2013	VDE123198

IEC 60335-2-14					
Clause	Requirement + Test			Result - Remark	Verdict
PCB	KINGBOARD LAMINATES HOLDINGS LTD	KB-3151C	V-0; 130	EN 60335-2-14 IEC 60335-2-14: 2016 EN 60335-1 IEC 60335-1:2010+A1+A2	Tested with appliance ULE123995
Supplementary information: 1) Provided evidence ensures the agreed level of compliance. See OD-CB2039.					

28.1	TABLE: Threaded part torque test			N/A
Threaded part identification	Diameter of thread (mm)	Column number (I, II, or III)	Applied torque (Nm)	
Supplementary information:				

29.1	TABLE: Clearances					P
	Overvoltage category.....				II	
		Type of insulation:				
Rated impulse voltage (V):	Min. cl (mm)	Basic (mm)	Supplementary (mm)	Reinforced (mm)	Functional (mm)	Verdict / Remark
330	0,2* / 0,5 / 0,8**					N/A
500	0,2* / 0,5 / 0,8**					N/A
800	0,2* / 0,5 / 0,8**					N/A
1 500	0,5 / 0,8** / 1,0***					N/A
2 500	1,5 / 2,0***		8,0		3,5	P
4 000	3,0 / 3,5***			1)8,1 2)10,0		P
6 000	5,5 / 6,0***					N/A
8 000	8,0 / 8,5***					N/A
10 000	11,0 / 11,5***					N/A

Supplementary information:
 *) For tracks on printed circuit boards if pollution degree 1 and 2
 **) For pollution degree 3
 ***) If the construction is affected by wear, distortion, movement of the parts or during assembly

Remark:
 Supplementary insulation: between the internal wire / supply cord and accessible part;
 Reinforced insulation: 1) between the live part of motor winding and accessible part; 2) between the live part of switch and accessible part;
 Functional insulation: between L / N

IEC 60335-2-14			
Clause	Requirement + Test	Result - Remark	Verdict

29.2	TABLE: Creepage distances, basic, supplementary and reinforced insulation										P
Working voltage (V)	Creepage distance (mm)							Type of insulation			Verdict
	Pollution degree										
	1	2			3						
		Material group			Material group						
		I	II	IIIa/IIIb	I	II	IIIa/IIIb*)	B**)	S**)	R**)	Verdict
≤50	0,18	0,6	0,85	1,2	1,5	1,7	1,9		—	—	N/A
≤50	0,18	0,6	0,85	1,2	1,5	1,7	1,9	—		—	N/A
≤50	0,36	1,2	1,7	2,4	3,0	3,4	3,8	—	—		N/A
125	0,28	0,75	1,05	1,5	1,9	2,1	2,4		—	—	N/A
125	0,28	0,75	1,05	1,5	1,9	2,1	2,4	—		—	N/A
125	0,56	1,5	2,1	3,0	3,8	4,2	4,8	—	—		N/A
250	0,56	1,25	1,8	2,5	3,2	3,6	4,0		—	—	N/A
250	0,56	1,25	1,8	2,5	3,2	3,6	4,0	—	8,0m m	—	P
250	1,12	2,5	3,6	5,0	6,4	7,2	8,0	—	—	1)8,1 mm 2)10, 0mm	P
400	1,0	2,0	2,8	4,0	5,0	5,6	6,3		—	—	N/A
400	1,0	2,0	2,8	4,0	5,0	5,6	6,3	—		—	N/A
400	2,0	4,0	5,6	8,0	10,0	11,2	12,6	—	—		N/A
500	1,3	2,5	3,6	5,0	6,3	7,1	8,0		—	—	N/A
500	1,3	2,5	3,6	5,0	6,3	7,1	8,0	—		—	N/A
500	2,6	5,0	7,2	10,0	12,6	14,2	16,0	—	—		N/A
>630 and ≤800	1,8	3,2	4,5	6,3	8,0	9,0	10,0		—	—	N/A
>630 and ≤800	1,8	3,2	4,5	6,3	8,0	9,0	10,0	—		—	N/A
>630 and ≤800	3,6	6,4	9,0	12,6	16,0	18,0	20,0	—	—		N/A
>800 and ≤1000	2,4	4,0	5,6	8,0	10,0	11,0	12,5		—	—	N/A
>800 and ≤1000	2,4	4,0	5,6	8,0	10,0	11,0	12,5	—		—	N/A
>800 and ≤1000	4,8	8,0	11,2	16,0	20,0	22,0	25,0	—	—		N/A
>1000 and ≤1250	3,2	5,0	7,1	10,0	12,5	14,0	16,0		—	—	N/A
>1000 and ≤1250	3,2	5,0	7,1	10,0	12,5	14,0	16,0	—		—	N/A

IEC 60335-2-14											
Clause	Requirement + Test							Result - Remark			Verdict
>1000 and ≤1250	6,4	10,0	14,2	20,0	25,0	28,0	32,0	—	—		N/A
>1250 and ≤1600	4,2	6,3	9,0	12,5	16,0	18,0	20,0		—	—	N/A
>1250 and ≤1600	4,2	6,3	9,0	12,5	16,0	18,0	20,0	—		—	N/A
>1250 and ≤1600	8,4	12,6	18,0	25,0	32,0	36,0	40,0	—	—		N/A
>1600 and ≤2000	5,6	8,0	11,0	16,0	20,0	22,0	25,0		—	—	N/A
>1600 and ≤2000	5,6	8,0	11,0	16,0	20,0	22,0	25,0	—		—	N/A
>1600 and ≤2000	11,2	16,0	22,0	32,0	40,0	44,0	50,0	—	—		N/A
>2000 and ≤2500	7,5	10,0	14,0	20,0	25,0	28,0	32,0		—	—	N/A
>2000 and ≤2500	7,5	10,0	14,0	20,0	25,0	28,0	32,0	—		—	N/A
>2000 and ≤2500	15,0	20,0	28,0	40,0	50,0	56,0	64,0	—	—		N/A
>2500 and ≤3200	10,0	12,5	18,0	25,0	32,0	36,0	40,0		—	—	N/A
>2500 and ≤3200	10,0	12,5	18,0	25,0	32,0	36,0	40,0	—		—	N/A
>2500 and ≤3200	20,0	25,0	36,0	50,0	64,0	72,0	80,0	—	—		N/A
>3200 and ≤4000	12,5	16,0	22,0	32,0	40,0	45,0	50,0		—	—	N/A
>3200 and ≤4000	12,5	16,0	22,0	32,0	40,0	45,0	50,0	—		—	N/A
>3200 and ≤4000	25,0	32,0	44,0	64,0	80,0	90,0	100,0	—	—		N/A
>4000 and ≤5000	16,0	20,0	28,0	40,0	50,0	56,0	63,0		—	—	N/A
>4000 and ≤5000	16,0	20,0	28,0	40,0	50,0	56,0	63,0	—		—	N/A
>4000 and ≤5000	32,0	40,0	56,0	80,0	100,0	112,0	126,0	—	—		N/A
>5000 and ≤6300	20,0	25,0	36,0	50,0	63,0	71,0	80,0		—	—	N/A
>5000 and ≤6300	20,0	25,0	36,0	50,0	63,0	71,0	80,0	—		—	N/A
>5000 and ≤6300	40,0	50,0	72,0	100,0	126,0	142,0	160,0	—	—		N/A
>6300 and ≤8000	25,0	32,0	45,0	63,0	80,0	90,0	100,0		—	—	N/A
>6300 and ≤8000	25,0	32,0	45,0	63,0	80,0	90,0	100,0	—		—	N/A
>6300 and ≤8000	50,0	64,0	90,0	126,0	160,0	180,0	200,0	—	—		N/A
>8000 and ≤10000	32,0	40,0	56,0	80,0	100,0	110,0	125,0		—	—	N/A
>8000 and ≤10000	32,0	40,0	56,0	80,0	100,0	110,0	125,0	—		—	N/A
>8000 and ≤10000	64,0	80,0	112,0	160,0	200,0	220,0	250,0	—	—		N/A
>10000 and ≤12500	40,0	50,0	71,0	100,0	125,0	140,0	160,0		—	—	N/A

IEC 60335-2-14											
Clause	Requirement + Test							Result - Remark			Verdict
>10000 and ≤12500	40,0	50,0	71,0	100,0	125,0	140,0	160,0	—		—	N/A
>10000 and ≤12500	80,0	100,0	142,0	200,0	250,0	280,0	320,0	—	—		N/A
Supplementary information: *) Material group IIIb is allowed if the working voltage does not exceed 50 V **) B = Basic insulation, S = Supplementary insulation, R = Reinforced insulation Remark: Supplementary insulation: between the internal wire / supply cord and accessible part; Reinforced insulation: 1) between the live part of motor winding and accessible part; 2) between the live part of switch and accessible part;											

29.2	TABLE: Creepage distances, functional insulation								P
Working voltage (V)	Creepage distance (mm) Pollution degree							Verdict / Remark	
	1	2			3				
	Material group				Material group				
	I	II	IIIa/IIIb	I	II	IIIa/IIIb*)			
≤10	0,08	0,4	0,4	0,4	1,0	1,0	1,0	N/A	
50	0,16	0,56	0,8	1,0	1,4	1,6	1,8	N/A	
125	0,25	0,71	1,0	1,4	1,8	2,0	2,2	N/A	
250	0,42	1,0	1,4	2,0	2,5	2,8	3,2	P / 3,5 mm	
400	0,75	1,6	2,2	3,2	4,0	4,5	5,0	N/A	
500	1,0	2,0	2,8	4,0	5,0	5,6	6,3	N/A	
>630 and ≤800	1,8	3,2	4,5	6,3	8,0	9,0	10,0	N/A	
>800 and ≤1000	2,4	4,0	5,6	8,0	10,0	11,0	12,5	N/A	
>1000 and ≤1250	3,2	5,0	7,1	10,0	12,5	14,0	16,0	N/A	
>1250 and ≤1600	4,2	6,3	9,0	12,5	16,0	18,0	20,0	N/A	
>1600 and ≤2000	5,6	8,0	11,0	16,0	20,0	22,0	25,0	N/A	
>2000 and ≤2500	7,5	10,0	14,0	20,0	25,0	28,0	32,0	N/A	
>2500 and ≤3200	10,0	12,5	18,0	25,0	32,0	36,0	40,0	N/A	
>3200 and ≤4000	12,5	16,0	22,0	32,0	40,0	45,0	50,0	N/A	

IEC 60335-2-14										
Clause	Requirement + Test								Result - Remark	Verdict
>4000 and ≤5000	16,0	20,0	28,0	40,0	50,0	56,0	63,0		N/A	
>5000 and ≤6300	20,0	25,0	36,0	50,0	63,0	71,0	80,0		N/A	
>6300 and ≤8000	25,0	32,0	45,0	63,0	80,0	90,0	100,0		N/A	
>8000 and ≤10000	32,0	40,0	56,0	80,0	100,0	110,0	125,0		N/A	
>10000 and ≤12500	40,0	50,0	71,0	100,0	125,0	140,0	160,0		N/A	
Supplementary information: *) Material group IIIb is allowed if the working voltage does not exceed 50 V Functional insulation: between L / N										

30.1	TABLE: Ball Pressure Test of Thermoplastics				P
Allowed impression diameter (mm)				2,0 mm	—
Object/ Part No./ Material	Manufacturer/ trademark		Test temperature (°C)		Impression diameter (mm)
Motor brush holder	/		125°C		1,1mm
The gear of motor shaft	/		75°C		1,2 mm
Plastic enclosure	/		75°C		1,2 mm
Bottom enclosure	/		49,9+40=89,9°C		1,2 mm
Knob	/		75°C		1,2 mm
Motor bobbin	/		125°C		1,0 mm
Supplementary information:					

30.2	TABLE: Resistance to heat and fire - Glow wire tests							P
Object/ Part No./ Material	Manufacturer / trademark	Glow wire test (GWT); (°C)						Verdict
		550	650		750		850	
			te	ti	te	ti		
Switch shielding the holding plastic					3s	39s		P
Heat shrinkable tube					0s	0s		P
motor bobbin					0s	0s		P

IEC 60335-2-14								
Clause	Requirement + Test				Result - Remark			Verdict
Rotary switch (CJ-102)					0s	0s		P
Rotary switch (MFR01)					0s	0s		P
Interlock switch (THW-3, THW-16)					0s	0s		P
Interlock switch (KW4A(S))					0s	0s		P
Rubber tube					0s	0s		P
The gear of motor shaft		x						P
Plastic enclosure		x						P
Bottom enclosure		x						P
Knob		x						P
X2 capacitor			0s	0s				
Object/ Part No./ Material	Manufacturer / trademark	Glow-wire flammability index (GWFI), °C				GW ignition temp. (GWIT), °C		Verdict
		550	650	750	850	675	775	
The test specimen passed the glow wire test (GWT) with no ignition $[(t_e - t_i) \leq 2s]$ (Yes/No):								Yes
If no, then surrounding parts passed the needle-flame test of annex E (Yes/No)..... :								N/A
The test specimen passed the test by virtue of most of the flaming material being withdrawn with the glow-wire (Yes/No)?								Yes
Ignition of the specified layer placed underneath the test specimen (Yes/No)								No
Supplementary information: - 550 °C GWT not relevant (or applicable) to parts of material classified at least HB40 or if relevant HBF - The GWIT pre-selection option, the 850 °C GWFI pre-selection option, and the 850 °C GWT are not relevant (or applicable) for attended appliances								

30.2/30.4	TABLE: Needle- flame test (NFT)	P
------------------	--	----------

IEC 60335-2-14					
Clause	Requirement + Test			Result - Remark	Verdict
Object/ Part No./ Material	Manufacturer/ trademark	Duration of application of test flame (ta); (s)	Ignition of specified layer Yes/No	Duration of burning (tb) (s)	Verdict
PCB	--	30	No	0	P
Supplementary information: - NFT not relevant (or applicable) for Parts of material classified as V-0 or V-1 - NFT not relevant (or applicable) for Base material of PCBs classified as V-0 or if relevant VTM-0					

---End this report---

IEC 60335-1:2010/A2:2016			
Clause	Requirement - Test	Result - Remark	Verdict

ATTACHMENT TO TEST REPORT IEC 60335-1 Household and similar electrical appliances – Safety – Part 1: General requirements	
Differences according to:	IEC 60335-1:2010 /A2: 2016
Attachment Form No.:	IEC60335-1/A2_A
Attachment Originator:	SGS-CSTC
Master Attachment:	Date 2016-06

IEC 60335-1:2010/A2:2016			
Clause	Requirement - Test	Result - Remark	Verdict
7	Marking and instructions		—
7.1	<p><i>Replace the last dashed item in the first paragraph by the following:</i></p> <ul style="list-style-type: none"> - symbol IEC 60417-5180 (2003-02), for class III appliances. This marking is not necessary for appliances operated only by batteries (primary batteries or secondary batteries recharged outside of the appliance) or appliances powered by rechargeable batteries recharged in the appliance. <p><i>Add the following new sub clause:</i></p>		N/A
7.12.9	<p>For each language, the instructions specified in 7.12 and from 7.12.1 to 7.12.8 shall appear together before any other instructions supplied with the appliance. Alternatively, these instructions may be supplied with the appliance separately from any functional use booklet.</p>		P
	<p>They may follow the description of the appliance that identifies parts, or follow the drawings/sketches common to the languages of the instructions.</p> <p>In addition, instructions shall also be available in an alternative format such as on a website or on request from the user in a format such as a DVD.</p> <p><i>Compliance is checked by inspection.</i></p>		P
7.14	<p><i>Add the following as new second paragraph to the requirement:</i></p> <p>The signal words WARNING, CAUTION, DANGER if in the Latin alphabet shall be in uppercase having a height not less than</p> <ul style="list-style-type: none"> - 3,5 mm for appliances normally used on the floor; - 2,0 mm for portable appliances with a printable surface of less than 10 cm²; and - 3,0 mm for other appliances. <p>NOTE A height of 3,5 mm is similar to Arial 14 pt, 3,0 mm is similar to 12 pt Arial and 2,0 mm is similar to 8 pt Arial. Other typefaces might differ in the pt value.</p>		N/A
	<p>Uppercase letter of the text explaining the signal word shall be no smaller than 1,6 mm, with other letters according to the font size of the uppercase letter.</p>		N/A

IEC 60335-1:2010/A2:2016			
Clause	Requirement - Test	Result - Remark	Verdict
	Countries that do not use the Latin alphabet need to specify the minimum size of the script to be used taking into account what is specified for the Latin alphabet.		N/A
	Unless contrasting colours are used, moulded in, engraved, or stamped markings shall be either raised above or have a depth below the surface of at least 0,25 mm.		N/A
	<i>Replace the first paragraph of the test specification by the following: Compliance is checked by inspection, by measurement and by rubbing the marking by hand for 15 s with a piece of cloth soaked with water and again for 15 s with a piece of cloth soaked with petroleum spirit. The petroleum spirit to be used for the test is aliphatic solvent hexane.</i>		P
8.1.3	<i>Replace the note by the following. If a single switching action is obtained by a switching device, the switching device shall provide full disconnection and the clearances for full disconnection specified in 20.1.5.3 of IEC 61058-1:2000 shall be obtained from Table 22 of IEC 61058-1:2000 using the next higher step for rated impulse withstand voltage.</i>		N/A
	<i>For appliances provided with a supply cord and without a switching device in their supply circuit, a single switching action may be obtained by the withdrawal of the plug from a socket outlet. Compliance is checked by inspection and by manual test.</i>		N/A
13.2	<i>Replace the first paragraph by the following: The leakage current is measured by means of the circuit described in Figure 4 of IEC 60990:1999. For class 0I appliances and class I appliances, except parts of class II construction, C may be replaced by a low impedance ammeter responding to the rated frequency of the appliance.</i>		P
19.1	<i>Add the following to the penultimate paragraph of the test specification: If the control performs more than one function, only that aspect of the control under consideration is rendered inoperative. Other functions of the control may continue to operate normally.</i>		N/A
19.7	<i>In the third paragraph of the test specification, replace "class P2" by "class S2 or S3".</i>		N/A

IEC 60335-1:2010/A2:2016			
Clause	Requirement - Test	Result - Remark	Verdict
19.11.3	<p>Replace the text of the test specification but not the note, by the following.</p> <p>If the appliance incorporates a protective electronic circuit that operates to ensure compliance with Clause 19, the appliance is tested as follows:</p> <p>A fault as indicated in a) to g) of 19.11.2 shall be incorporated in the protective electronic circuit either before the appliance is started or at any point in time after the appliance is started so that the most unfavourable conditions of the test are applied.</p>		N/A
	<p>If the appliance is able to operate after the fault in the protective electronic circuit is incorporated, then the appliance is further tested as follows.</p>		N/A
	<p>For appliances for continuous operation the appliance is operated until steady conditions are reached. Then the relevant test of Clause 19 is repeated.</p>		N/A
	<p>Other appliances are operated for one cycle of operation. Then the relevant test of Clause 19 is repeated.</p>		N/A
19.11.4.2	<p>Replace the test specification but not the note, by the following:</p> <p>The appliance is subjected to radiated fields in accordance with IEC 61000-4-3.</p> <p>The frequency ranges tested shall be:</p> <ul style="list-style-type: none"> - 80 MHz to 1 000 MHz, test level 3; - 1,4 GHz to 2,0 GHz, test level 3; - 2,0 GHz to 2,7 GHz, test level 2. 		N/A
22.5	<p>Replace the requirement by the following:</p> <p>Appliances intended to be connected to the supply mains by means of a plug or pins for insertion into socket-outlets shall be constructed so that in normal use, when pins are touched, there is no risk of electric shock from charged capacitors having a rated capacitance equal to or greater than 0,1 µF.</p>		P

IEC 60335-1:2010/A2:2016			
Clause	Requirement - Test	Result - Remark	Verdict
22.12	<p><i>Replace the requirement by the following:</i> Handles, knobs, grips, levers and parts providing a similar function shall be fixed in a reliable manner so that they will not work loose in normal use if loosening could result in a hazard, including a choking hazard. If these parts are used to indicate the position of switches or similar components, it shall not be possible to remove or fix them incorrectly if this could result in a hazard. The requirement concerning the choking hazard does not apply to appliances intended for commercial use. <i>Add the following new paragraph to the test specification:</i></p>		P
	<p><i>If the part is removed and can be contained within the small parts cylinder in Figure 13, its loosening is considered to result in a choking hazard.</i> <i>Add the following new subclauses:</i></p>		N/A
22.55	<p>Devices that are operated by the user to stop the intended function of the appliance, if any, shall be distinguished from other manual devices by means of shape, or size, or surface texture, or position. This requirement concerning position does not preclude use of a push on push off switch. An indication when the device has been operated shall be given by:</p> <ul style="list-style-type: none"> - tactile feedback from the actuator or tactile feedback from the appliance such as stopping of the vibration on the body of the appliance or of a part of it; or - reduction in heat output; or - audible and visible feedback. 		P
	<p>The sound of the motor or sound of an actuator switching from on to off is considered as an audible feedback. A switch with a stable off-position different from the on-position is considered visual and tactile feedback. The force feedback from the actuator when operating it is considered to be tactile feedback. <i>Compliance is checked by inspection and by manual test.</i></p>		P

IEC 60335-1:2010/A2:2016			
Clause	Requirement - Test	Result - Remark	Verdict
22.56	<p>Detachable power supply part shall be provided with the part of class III construction of the appliance. <i>Compliance is checked by inspection.</i></p>		N/A
22.57	<p>The properties of non-metallic materials shall not degrade from exposure to UV-C radiation generated from UV sources provided for microbiological control within the appliance such that they no longer comply with this standard. This requirement does not apply to glass, ceramics or similar materials. <i>Compliance is checked by the conditioning and tests of Annex T.</i></p>		N/A
24.2	<p><i>Replace the first dashed item of 24.2 by the following.</i></p> <ul style="list-style-type: none"> - switches, automatic controls, power supplies and the like in flexible cords; 		P
24.8	<p><i>In the first dashed item of the second paragraph of the requirement replace "class of safety protection P2" by "class of safety protection S2 or S3".</i></p>		N/A
25.7	<p><i>Add to the end of the dashed items:</i></p> <ul style="list-style-type: none"> - Halogen-free, low smoke, thermoplastic insulated and sheathed <p>Their properties should at least be those of:</p> <ul style="list-style-type: none"> · Light duty halogen-free low smoke flexible cable (code designation 62821 IEC 101 for circular cable and code designation 62821 IEC 101f for flat cable); · Ordinary duty halogen-free, low smoke flexible cable (code designation 62821 IEC 102 for circular cable and code designation 62821 IEC 102f for flat cable). 		N/A
25.10	<p><i>Add the following to the requirement as a new third paragraph:</i></p> <p>Where additional neutral conductors are provided in the supply cord</p> <ul style="list-style-type: none"> - other colours may be used for these additional neutral conductors; - all of the neutral conductors and line conductors shall be identified by marking using the alpha numeric notation specified in IEC 60445; - the supply cord shall be fitted to the appliance. 		P

IEC 60335-1:2010/A2:2016			
Clause	Requirement - Test	Result - Remark	Verdict
25.23	<p><i>Add the following new dashed item to the requirement:</i></p> <p>- for class III construction, interconnection cords of a class I appliance or class II appliance, the cross sectional areas of the conductors need not comply with 25.8 if the temperature of the cord insulation specified in Table 3 and Table 9 are not exceeded during the tests of Clause 11 and Clause 19, respectively.</p>		N/A
Annex B	Appliances powered by rechargeable batteries that are recharged in the appliance		--
7.12	<p><i>Replace the third paragraph and three dashed items by the following:</i></p> <p>Instructions for appliances containing non user-replaceable batteries shall state the substance of the following: This appliance contains batteries that are only replaceable by skilled persons.</p>		N/A
	<p>Instructions for appliances containing non-replaceable batteries shall state the substance of the following: This appliance contains batteries that are non-replaceable.</p>		N/A
Annex P	- Guidance for the application of this standard to appliances used in warm damp equable climates		N/A
Annex T	UV-C radiation effect on non-metallic materials		N/A

Attachment 2

IEC60335_2_14P - ATTACHMENT			
Clause	Requirement - Test	Result - Remark	Verdict

<p>ATTACHMENT TO TEST REPORT IEC 60335-2-14 EUROPEAN GROUP DIFFERENCES AND NATIONAL DIFFERENCES</p> <p>Household and similar electrical appliances – Safety – Part 2: Particular requirements for kitchen machines</p>	
Differences according to:	EN 60335-2-14:2006 + A1:2008 + A11:2012 used in conjunction with EN 60335-1:2012+AC1:2012+A11:2014 EN 62233:2008
Attachment Form No.:	EU_GD_IEC60335_2_14P
Attachment Originator:	SGS-CSTC
Master Attachment:	2017-07

Attachment 2

IEC60335_2_14P - ATTACHMENT			
Clause	Requirement - Test	Result - Remark	Verdict

CENELEC COMMON MODIFICATIONS			
6.1	Delete “class 0” and “class 01”		P
	Class II or class III for hand-held kitchen machines (EN 60335-2-14)		N/A
7.1	Single-phase appliances to be connected to the supply mains: 230 V covered		P
	Multi-phase appliances to be connected to the supply mains: 400 V covered		N/A
7.10	The accessible switch required by 22.40 distinguished from other manual devices by means of shape, or size, or surface texture, or position, etc. (EN 60335-2-14)		P
	An indication that the device has been operated is given by:		—
	• a tactile feedback, or		P
	• an audible and visual feedback		N/A
	A selector switch with an off-position clearly identifiable is allowed (EN 60335-2-14)		P
	An ON/OFF switch, if any, is considered a suitable device to stop operational functions (EN 60335-2-14)		N/A
	A plug is not considered a suitable device to stop operational functions, as it can be difficult to be reached by vulnerable persons (EN 60335-2-14)		P
7.12	The instructions include the substance of the following:		—
	- this appliance can be used by children aged from 8 years and above and persons with reduced physical, sensory or mental capabilities or lack of experience and knowledge if they have been given supervision or instruction concerning use of the appliance in a safe way and understand the hazards involved		P
	- children shall not play with the appliance		P
	- cleaning and user maintenance shall not be made by children without supervision		P
	The instructions for appliances warn against misuse (EN 60335-2-14)		P
	The instructions include the substance of the following: (EN 60335-2-14, A11:2012)		—

Attachment 2

IEC60335_2_14P - ATTACHMENT			
Clause	Requirement - Test	Result - Remark	Verdict
	Always disconnect the appliance from the supply if it is left unattended and before assembling, disassembling or cleaning (EN 60335-2-14)		P
	The instructions for bean slicers, berry-juice extractors, blenders and hand-held blenders churns, centrifugal juicers, coffee mills, food mixers, food processors, grain grinders, knife sharpeners, knives, mincers, noodle makers, potato peelers, shredders, sieving machines and slicing machines include the substance of the following: (EN 60335-2-14)		—
	This appliance shall not be used by children. Keep the appliance and its cord out of reach of children (EN 60335-2-14)		P
	The instructions for can openers, citrus-fruit squeezers, cream whippers, egg beaters, graters and ice-cream machines include the substance of the following: (EN 60335-2-14)		—
	This appliance can be used by children aged from 8 years and above if they have been given supervision or instruction concerning use of the appliance in a safe way and if they understand the hazards involved (EN 60335-2-14)		N/A
	Cleaning and user maintenance shall not be made by children unless they are aged from 8 years and above and supervised (EN 60335-2-14)		N/A
	Keep the appliance and its cord out of reach of children aged less than 8 years (EN 60335-2-14)		N/A
	The instructions also include the substance of the following: (EN 60335-2-14)		—
	Appliances can be used by persons with reduced physical, sensory or mental capabilities or lack of experience and knowledge if they have been given supervision or instruction concerning use of the appliance in a safe way and if they understand the hazards involved (EN 60335-2-14)		P
	Children shall not play with the appliance (EN 60335-2-14)		P
7.12.Z1	The specific instructions related to the safe operation of this appliance is collated together in the front section of the user instructions		P
	The height of the characters, measured on the capital letters, is at least 3 mm		P
	These instructions are also available in an alternative format, e.g. on a website	website	P
8.1.1	Also test probe 18 of EN 61032 is applied		P

Attachment 2

IEC60335_2_14P - ATTACHMENT			
Clause	Requirement - Test	Result - Remark	Verdict
	The appliance being in every possible position during the test		P
	The force on the probe in the straight position is increased to 10 N when probe 18 is used		P
	When using test probe 18 the appliance is fully assembled as in normal use without any parts removed, and		P
	parts intended to be removed for user maintenance are also not removed		P
8.2	Compliance is checked by applying the test probes of EN 61032		P
	For built-in appliances and fixed appliances, the test probe B and probe 18 of EN 61032 are applied only after installation		N/A
11.8	Footnotes to “External enclosure of motor-operated appliances” to be taken into account		P
	Add the following Table Z101 (EN 60335-2-14)		P
15.1.2	Appliances with an automatic cord reel tested with the cord in the most unfavourable position so that the reeling of the wet cord may affect electrical insulation during operation, the cord not being dried before reeling		N/A
20.2	When using the test probe similar to test probe B with a circular stop face, the accessories and detachable covers are removed		P
	Test probe 18 applied with a force of 2,5N on the appliance fully assembled		P
	Test probe B not applied to:	(EN 60335-2-14)	—
	- appliances specified in the list		N/A
	- the following parts of other appliances:		N/A
	smooth shafts having a diameter not exceeding 8 mm, rotating at a speed not exceeding 1 500 r/min and driven by motors having an input not exceeding 200 W		N/A
	outlet sides of grating and shredding disks rotating at a speed not exceeding 1 500 r/min		N/A
	projections from the surface of grinding disks, cones and similar parts having a height less than 4 mm		N/A
	Test probe 18 not applied to:	(EN 60335-2-14)	—

Attachment 2

IEC60335_2_14P - ATTACHMENT			
Clause	Requirement - Test	Result - Remark	Verdict
	- appliances specified in the list	Blender	P
	- the following parts of other appliances:		N/A
	smooth shafts having a diameter not exceeding 8 mm, rotating at a speed not exceeding 1 500 r/min and driven by motors having an input not exceeding 200 W		N/A
	outlet sides of grating and shredding disks rotating at a speed not exceeding 1 500 r/min		N/A
	projections from the surface of grinding disks, cones and similar parts having a height less than 4 mm		N/A
21.Z101	Drop test for hand-held appliances (EN 60335-2-14)		N/A
	The appliance not damaged to such an extent that compliance with this standard, in particular with Clauses 8 and 29, is impaired (EN 60335-2-14)		N/A
24.1	Components comply with the safety requirements specified in the relevant standards as far as they reasonably apply		P
	The requirements of Clause 29 of this standard apply between live parts of components and accessible parts of the appliance.		P
	The requirements of 30.2 of this standard apply to parts of non-metallic material in components including parts of non-metallic material supporting current-carrying connections inside components		P
	Components that have not been previously tested or do not comply with the standard for the relevant component are tested according to the requirements of 30.2		P
	Components that have been previously tested and shown to comply with the resistance to fire requirements in the standard for the relevant component need not be retested provided that:		—
	- the severity specified in the component standard is not less than the severity specified in 30.2, and		P
	- the test report for the component states whether it complied with the standard for the relevant component with or without flame, flames not exceeding 2 s during the test are ignored		N/A

Attachment 2

IEC60335_2_14P - ATTACHMENT			
Clause	Requirement - Test	Result - Remark	Verdict
	Unless components have been previously tested and found to comply with the relevant standard for the number of cycles specified, they are tested in accordance with 24.1.1 to 24.1.9		N/A
	For components mentioned in 24.1.1 to 24.1.9, no additional tests specified in the relevant standard for the component are necessary other than those specified in 24.1.1 to 24.1.9		P
	Components that have not been separately tested and found to comply with the relevant standard, and		P
	components that are not marked or not used in accordance with their marking,		P
	are tested in accordance with the conditions occurring in the appliance, the number of samples being that required by the relevant standard		P
	Lamp holders and starter holders that have not been previously tested and found to comply with the relevant standard are tested as a part of the appliance and additionally comply with the gauging and interchangeability requirements of the relevant standard under the conditions occurring in the appliance		N/A
	Where the relevant standard specifies these gauging and interchangeability requirements at elevated temperatures, the temperatures measured during the tests of Clause 11 are used		N/A
	Plugs and socket-outlets and other connecting devices of interconnection cords are not interchangeable with plugs and socket-outlets listed in IEC/TR 60083 or IEC 60906-1, or		P
	with connectors and appliance inlets complying with the standard sheets of IEC 60320-1,		N/A
	if direct supply to these parts from the supply mains gives rise to a hazard		N/A
24.1.7	If the remote operation of the appliance is via a telecommunication network, the relevant standard for the telecommunication interface circuitry in the appliance is EN 41003		N/A
	Compliance with Clause 8 of this standard is not impaired by connecting the appliance to a device covered by EN 41003		N/A

Attachment 2

IEC60335_2_14P - ATTACHMENT			
Clause	Requirement - Test	Result - Remark	Verdict
24.Z1	For motor running capacitors (IEC 60252-1 type P2) with a metallic enclosure having an overpressure fuse the flame testing of internal plastic parts supporting current carrying connections as required in 30.2.2 and 30.2.3.1 is not necessary		N/A
25.6	Supply cords of single-phase portable appliances having a rated current not exceeding 16 A, fitted with a plug complying with the following standard sheets of IEC/TR 60083:		—
	- for Class I appliances: standard sheet C2b, C3b or C4		N/A
	- for Class II appliances: standard sheet C5 or C6	C5	P
25.7	Rubber sheathed cords (60245 IEC 53) are not suitable for appliances intended to be used outdoors or when they are liable to be exposed to significant amount of ultraviolet radiation		N/A
	Halogen-free thermoplastic compound sheathed supply cords have properties at least those of:		—
	<ul style="list-style-type: none"> halogen-free thermoplastic compound sheathed cords (H03Z1Z1H2-F or H03Z1Z1-F), for appliances having a mass not exceeding 3 kg 		N/A
	<ul style="list-style-type: none"> halogen-free thermoplastic compound sheathed cords (H05Z1Z1H2-F or H05Z1Z1-F), for other appliances 		N/A
	Cross-linked halogen-free compound sheathed supply cords have properties at least those of cross-linked halogen-free compound sheathed cords (H07ZZ-F)		N/A
26.11	Conductors connected by soldering are not considered to be positioned or fixed so that reliance is not placed upon the soldering alone to maintain them in position unless they are held in place near the terminals independently of the solder		P
29.3.Z1	Appliance constructed so that if there is a possibility of damaging the insulation during installation, the insulation withstands the scratch and penetration test of 21.2		N/A
32	Compliance regarding electromagnetic fields is checked according to EN 62233	EN 62233	P

Attachment 2

IEC60335_2_14P - ATTACHMENT			
Clause	Requirement - Test	Result - Remark	Verdict
Annex I, 19.1.101	The appliance is supplied at rated voltage and operated under normal operation with each of the fault conditions specified		N/A
	The duration of the test is as specified in 19.7		N/A

Attachment 2

IEC60335_2_14P - ATTACHMENT			
Clause	Requirement - Test	Result - Remark	Verdict
ZA	ANNEX ZA (NORMATIVE) SPECIAL NATIONAL CONDITIONS		--
	Norway		--
19.5	The test is also applicable to appliances intended to be permanently connected to fixed wiring		Not checked
	Norway		--
22.2	The second paragraph of this subclause, dealing with single-phase, permanently connected class I appliances having heating elements, is not applicable due to the supply system		Not checked
	All CENELEC countries		--
25.6 and 25.25	Information concerning National plug and socket-outlets is available from the CENELEC website. Normative national requirements concerning plug and socket-outlets are shown in the relevant National standard		P
	Ireland and United Kingdom		--
25.8	In the table, the lines for 10 A and 16 A are replaced by:		--
	> 10 and ≤ 13 1,25		Not checked
	> 13 and ≤ 16 1,5		Not checked
ZB	ANNEX ZB (INFORMATIVE) A-DEVIATIONS		--
	Ireland		--
25.6	These regulations apply to all plugs for domestic use at a voltage of not less than 200 V and in general allow only plugs complying with I.S. 401:1997, or equivalent, to be fitted to domestic appliances		Not checked

Attachment 2

IEC60335_2_14P - ATTACHMENT			
Clause	Requirement - Test	Result - Remark	Verdict
	United Kingdom		--
25.6	These regulations apply to all plugs for domestic use at a voltage of not less than 200 V and in general allow only plugs to BS 1363 to be fitted to domestic appliances. It also allows plugs to BS 4573 and EN 50075 to be fitted to shavers and toothbrushes		Not checked
ZC	ANNEX ZC (NORMATIVE) NORMATIVE REFERENCES TO INTERNATIONAL PUBLICATIONS WITH THEIR CORRESPONDING EUROPEAN PUBLICATIONS		--
	A list of referenced documents in this standard		P
ZD	ANNEX ZD (INFORMATIVE) IEC and CENELEC CODE DESIGNATIONS FOR FLEXIBLE CORDS		--
	A table with IEC and CENELEC code designations for flexible cords		P
ZE	ANNEX ZE (INFORMATIVE) SPECIFIC ADDITIONAL REQUIREMENTS FOR APPLIANCES AND MACHINES INTENDED FOR COMMERCIAL USE		--
7.1	Business name and full address of the manufacturer and, where applicable, his authorized representative.....:		N/A
	Model or type reference		N/A
	Serial number, if any		N/A
	Production year		N/A
	Designation of the appliance.....:		N/A
7.12	Instructions provided with the appliance so that the appliance can be used safely		N/A
	The instructions contain at least the following information:		--
	- the business name and full address of the manufacturer and, where applicable, his authorized representative		N/A
	- model or type reference of the appliance as marked on the appliance itself, except for the serial number		N/A

Attachment 2

IEC60335_2_14P - ATTACHMENT			
Clause	Requirement - Test	Result - Remark	Verdict
	- the designation of the appliance together with its explanation in case it is given by a combination of letters and/or numbers		N/A
	- the general description of the appliance, when needed due to the complexity of the appliance		N/A
	- specific precautions if required during installation, operation, adjusting, user maintenance, cleaning, repairing or moving		N/A
	- when needed drawings, diagrams, descriptions and explanations necessary for the safe use and user maintenance of the appliance		N/A
	- the possible reasonably foreseeable misuse and, whenever relevant, a warning against the effects it may have on the safe use of the appliance		N/A
	The words "Original instructions" appear on the language version(s) verified by the manufacturer or by the authorized representative		N/A
	When a translation of the original instructions has been provided by a person introducing the appliance on the market; the meaning of the sentence "Translation of the original instructions" appear in the relevant instructions delivered with the appliance		N/A
	The instructions for maintenance/service to be done by specialized personnel, mandated by the manufacturer or the authorized representative may be supplied in only one Community language which the specialized personnel understand		N/A
	The instructions indicate the type and frequency of inspections and maintenance required for safe operation including the preventive maintenance measures		N/A
7.12.ZE1	If needed for specific appliances, the following information to be given:		--
	<ul style="list-style-type: none"> on use, transportation, assembly, dismantling when out of service, testing or foreseeable breakdowns, if these operations have consequences on stability of the appliance in order to avoid overturning, falling or uncontrolled movements of the appliance or of its component parts 		N/A
	<ul style="list-style-type: none"> on how to maintain adequate mechanical stability when in use, during transportation, assembly, dismantling, scrapping and any other action involving the appliance 		N/A

Attachment 2

IEC60335_2_14P - ATTACHMENT			
Clause	Requirement - Test	Result - Remark	Verdict
	<ul style="list-style-type: none"> on the protective measures to be taken by the user, including, where appropriate, the personal protective equipment to be provided 		N/A
	<ul style="list-style-type: none"> on the operating method to be followed in the event of accident or breakdown; if a blockage is likely to occur the operating method to safely unblock the appliance 		N/A
	<ul style="list-style-type: none"> on the specifications on the spare parts to be used, when these affect the health and safety of the operator 		N/A
	<ul style="list-style-type: none"> on airborne noise emissions, determined and declared in accordance with the relevant Part 2, which includes: 		--
	<ul style="list-style-type: none"> - the A-weighted emission sound pressure level at workstations, where this exceeds 70 dB(A) 		N/A
	<ul style="list-style-type: none"> - where this level does not exceed 70 dB(A), this fact is indicated 		N/A
	<ul style="list-style-type: none"> - the peak C-weighted instantaneous sound pressure value at workstations, where this exceeds 63 Pa (130 dB in relation to 20 µPa)..... 		N/A
	<ul style="list-style-type: none"> - the A-weighted sound power level emitted by the machinery, where the A-weighted emission sound pressure level at workstations exceeds 80 dB(A) 		N/A
7.12.ZE2	The instructions includes a warning to disconnect the appliance from its power source during service and when replacing parts		N/A
	If the removal of the plug is foreseen, it is clearly indicated that the removal of the plug has to be such that an operator can check from any of the points to which he has access that the plug remains removed		N/A
	If this is not possible, due to the construction of the appliance or its installation, a disconnection with a locking system in the isolated position is provided		N/A
19.11.4.8	The appliance continues to operate, without causing any hazard to the user, from the same point in its operating cycle at which the voltage fluctuation occurred, or		N/A
	a manual operation is required to restart it		N/A

Attachment 2

IEC60335_2_14P - ATTACHMENT			
Clause	Requirement - Test	Result - Remark	Verdict
20.1	Appliances and their components and fittings have adequate mechanical stability during transportation, assembly, dismantling and any other action involving the appliance		N/A
20.2	Dangerous moving transmission parts safeguarded either by design or guards		N/A
	When guards are used, they are fixed guards, interlocking movable guards or protective devices		N/A
	Moving parts directly involved in the function of the appliance which cannot be made completely inaccessible fitted with:		--
	- fixed guards or interlocking movable guards preventing access to those sections of the parts that are not used in the work, and		N/A
	- adjustable guards restricting access to those sections of the moving parts where access is necessary		N/A
	Interlocking movable guards used where frequent access is required		N/A
21.1	Appliances and their components and fittings have adequate mechanical strength and is constructed to withstand such rough handling that may be expected in normal use, during transportation, assembly, dismantling, scrapping and any other action involving the appliance		N/A
22.ZE.1	For appliances provided with a seat, the seat gives adequate stability		N/A
	The distance between the seat and the control devices capable of being adapted to the operator		N/A
22.ZE.2	For appliances provided with separate devices for the start and the stop functions, the stop function is unambiguously identifiable and does always override the start function		N/A
	For appliances provided with one device performing the start and the stop function, the stop function is unambiguously identifiable and does always override the start function		N/A
22.ZE.3	Appliances designed in such a way that incorrect mounting is avoided, if this can lead to an unsafe situation		N/A
	If this is not possible, information on the correct mounting is given directly on the part and/or the enclosure		N/A

Attachment 2

IEC60335_2_14P - ATTACHMENT			
Clause	Requirement - Test	Result - Remark	Verdict
22.ZE.4	Where the weight, size or shape prevents appliances from being moved manually, they are fitted with attachments for lifting gear, or		N/A
	so designed that they can be fitted with such attachments, or		N/A
	be shaped in such a way that standard lifting gear can easily be used		N/A
	Appliances to be moved manually are constructed or equipped so that they can be moved easily and safely		N/A
22.ZE.5	The fixing systems of fixed guards which prevent access to dangerous moving transmission parts only removable with the use of tools		N/A
	If such guards have to be removed by the user for routine cleaning or maintenance their fixing systems remain attached to the fixed guards or to the machine after removal		N/A
	Where possible, guards are incapable of remaining in place without their fixings		N/A
	This does not apply if, after removal of the screws, or if the component is incorrectly repositioned, the appliance becomes inoperative		N/A
	Movable guards are interlocked		N/A
	The interlocking devices prevent the start of hazardous appliance functions until the guards are fixed in their position, and give a stop command whenever they are no longer closed		N/A
	Where it is possible for an operator to reach the danger zone before the risk due to hazardous appliance functions has ceased, movable guards associated with a guard locking device in addition to an interlocking device that:		--
	- prevents the start of hazardous appliance functions until the guard is closed and locked, and		N/A
	- keeps the guard closed and locked until the risk of injury from the hazardous appliance functions has ceased		N/A
	Interlocking movable guards remain attached to the appliance when open, and		N/A
	they are designed and constructed in such a way that they can be adjusted only by means of an intentional action		N/A

Attachment 2

IEC60335_2_14P - ATTACHMENT			
Clause	Requirement - Test	Result - Remark	Verdict
22.ZE.6	Interlocking movable guards designed in such a way that the absence or failure of one of their components prevents starting or stops the hazardous appliance functions		N/A
	The guard is opened to the extent needed to cause the interlocking to operate and is then closed, the number of operations being defined in the specific Part 2.....:		N/A
	After this test any defect that may be expected in normal use is applied to the interlock system, including interruption of the supply, only one defect being simulated at a time		N/A
	After these tests the interlock system is fit for further use		N/A
22.ZE.7	Adjustable guards restricting access to areas of the moving parts strictly necessary for the work are:		--
	- adjustable manually or automatically, depending on the type of work involved, and		N/A
	- readily adjustable without the use of tools		N/A
22.ZE.8	In case of interruption, re-establishment after an interruption or fluctuation in whatever manner of the power supply, the appliance does not restart		N/A
	However, automatic restarting of the operation is allowed if the appliance may continue to operate, without causing any hazard to the user, from the same point in its operating cycle at which the voltage interruption or fluctuation occurred		N/A
22.ZE.9	Appliances fitted with means to isolate them from all energy sources		N/A
	Such isolators are clearly identified, and		N/A
	they are capable of being locked if reconnection endanger persons		N/A
	After the energy source is disconnected, it is possible to dissipate any energy remaining or stored in the circuits of the appliance without risk to persons		N/A
ZF	ANNEX ZF (INFORMATIVE) CRITERIA APPLIED FOR THE ALLOCATION OF PRODUCTS COVERED BY STANDARDS IN THE EN 60335 SERIES UNDER LVD OR MD		--

Attachment 2

IEC60335_2_14P - ATTACHMENT			
Clause	Requirement - Test	Result - Remark	Verdict
	List of standards under CENELEC/TC61 with the allocation under the LVD (Low Voltage Directive) or the MD (Machinery Directive).....:		P
ZG	ANNEX ZG (NORMATIVE) UV APPLIANCES		--
	The following modifications to this standard apply to appliances having UV emitters		N/A
	This annex is not applicable to appliances covered by the scopes of IEC 60335-2-27, IEC 60335-2-59 or IEC 60335-2-109		N/A
7.12.ZG	The instructions for appliances incorporating UVC emitters include the substance of the following: WARNING — This appliance contains a UV emitter. Do not stare at the light source		N/A
32	For appliances incorporating UV emitters the manufacturer delivers a declaration providing evidence that the plastic material exposed to the radiation is UV resistant		N/A
ZZ	ANNEX ZZ (INFORMATIVE) COVERAGE OF ESSENTIAL REQUIREMENTS OF EC DIRECTIVES		--
	Description of the relation between this European standard and the LVD (Low Voltage Directive, 2006/95/EC) and the MD (Machinery Directive, 2006/42/EC)		P

Attachment 2

IEC60335_2_14P - ATTACHMENT

Annex EN 62233:2008			
Clause	Requirement + Test	Result - Remark	Verdict
EMF- ELECTROMAGNETICS FIELDS			
	The tested product also complies with the requirements of EN 62233:2008		--
	Limit100%	Measured max.: 3,146 %	P

---End of this attachment 2 ---

Attachment 3

EN 60335-2-14:2006/A12: 2016			
Clause	Requirement - Test	Result - Remark	Verdict

ATTACHMENT OF TEST REPORT IEC 60335-2-14 Household and similar electrical appliances – Safety – Part 2-2: Particular requirements for vacuum cleaners and water-suction cleaning appliances	
Differences according to:	EN 60335-2-14:2006/A12: 2016
Attachment Form No.:	IEC 60335_2_14: 2006
Attachment Originator:	SGS-CSTC
Master Attachment:	2014-07

5.2	<i>Addition:</i>	—
	The tests of 21.Z101 are carried out on separate appliances.”	N/A
	<i>Note 101</i> Three additional coffee mills and grain grinders are required for the test of 19.102.	P
	<i>NOTE 102</i> The additional test of 25.14 is carried out on a separate appliance.	N/A
7	Marking	—
7.10	Replace the text of Part 1 “Devices used to start/stop operational ... or position, etc.” by the following:	—
	The accessible switch required by 22.40 shall be distinguished from other manual devices by means of shape, or size, or surface texture, or position, etc.	P
7.12	Modification:	—
	Delete the third and fourth paragraph of Part 1 “The instructions shall include the substance of the following: ... children without supervision.	P
	Addition	—
	The instructions shall include the substance of the following:	P
	Always disconnect the appliance from the supply if it is left unattended and before assembling, disassembling or cleaning.	P
	The instructions for bean slicers, berry-juice extractors, blenders and hand-held blenders churns, centrifugal juicers, coffee mills, food mixers, food processors , grain grinders, knife sharpeners, knives, mincers , noodle makers, potato peelers, shredders, sieving machines and slicing machines shall include the substance of the following:	P
	This appliance shall not be used by children. Keep the appliance and its cord out of reach of children.	P

Attachment 3

EN 60335-2-14:2006/A12: 2016			
Clause	Requirement - Test	Result - Remark	Verdict
	The instructions for can openers, citrus-fruit squeezers, cream whippers, egg beaters, graters and ice-cream machines shall include the substance of the following:		N/A
	This appliance can be used by children aged from 8 years and above if they have been given supervision or instruction concerning use of the appliance in a safe way and if they understand the hazards involved. Cleaning and user maintenance shall not be made by children unless they are aged from 8 years and above and supervised. Keep the appliance and its cord out of reach of children aged less than 8 years.		N/A
	The instructions shall also include the substance of the following:		P
	Appliances can be used by persons with reduced physical, sensory or mental capabilities or lack of experience and knowledge if they have been given supervision or instruction concerning use of the appliance in a safe way and if they understand the hazards involved.		P
	Children shall not play with the appliance.		P
11	Heating		—
11.8	<i>Modification</i>		—
	<i>Replace the first sentence of Part 1 by the following:</i>		—
	<i>During the test, the temperature rises are monitored continuously and shall not exceed the values shown in Table 3 and Table Z101".</i>		P
	<i>In Table 3, delete the row "External enclosure of motor-operated appliances, except handles held in normal use" and the corresponding footnotes.</i>		P
	<i>Add the following Table Z101.</i>		P
20	Stability and mechanical hazards		—
20.2	Add the following before the last sentence of the compliance clause:		—
	<i>The test probe B is not applied to:</i>		—

Attachment 3

EN 60335-2-14:2006/A12: 2016			
Clause	Requirement - Test	Result - Remark	Verdict
	<p><i>a) bean slicers;</i> <i>b) can openers;</i> <i>c) citrus juice squeezers;</i> <i>d) food mixers;</i> <i>e) hand-held blenders;</i> <i>f) ice-cream machines, including those for use in refrigerators and freezers;</i> <i>g) knife sharpeners;</i> <i>h) knives;</i> <i>i) potato peelers;</i> <i>j) sieving machines;</i> <i>k) slicing machines;</i> <i>l) the following parts of other appliances:</i> <i>1) smooth shafts having a diameter not exceeding 8 mm, rotating at a speed not exceeding 1 500 r/min and driven by motors having an input not exceeding 200 W;</i> <i>2) outlet sides of grating and shredding disks rotating at a speed not exceeding 1 500 r/min;</i> <i>3) projections from the surface of grinding disks, cones and similar parts having a height less than 4 mm.</i></p>		N/A
	<p><i>NOTE Z101 Accessible drive shafts that may not be in use when the appliance is in operation may be protected by means of a collar or by being positioned in a recess.</i></p>		N/A
	<p><i>The test probe 18 is not applied to:</i></p>		—

Attachment 3

EN 60335-2-14:2006/A12: 2016			
Clause	Requirement - Test	Result - Remark	Verdict
	<p>a) bean slicers; b) berry-juice extractors; c) blenders and hand-held blenders; d) can openers; e) citrus juice squeezers; f) centrifugal juicers; g) coffee mills not exceeding 500 g hopper capacity; h) churns; i) food mixers; j) food processors; k) grain grinders not exceeding 3 l hopper capacity; l) ice-cream machines, including those for use in refrigerators and freezers; m) knife sharpeners; n) knives; o) mincers; p) noodle makers; q) potato peelers; r) shredders; s) sieving machines; t) slicing machines; u) the following parts of other appliances: 1) smooth shafts having a diameter not exceeding 8 mm, rotating at a speed not exceeding 1 500 r/min and driven by motors having an input not exceeding 200 W; 2) outlet sides of grating and shredding disks rotating at a speed not exceeding i. 1 500 r/min; 3) projections from the surface of grinding disks, cones and similar parts having a height less than 4 mm.</p>		P
21	Mechanical strength		—
	<i>Additional subclause:</i>		—
21.Z101	<i>Hand-held appliances are subjected to the following test:</i>		N/A
	<i>The appliance is put on an horizontal surface 700 mm above a rigidly supported hardwood board and operated while supplied at rated voltage until normal load conditions are reached.</i>		N/A
	<i>It is then allowed to drop freely. The test is carried out three times, the appliance being held in different positions likely to occur. Each test shall be done on a new appliance.</i>		N/A
	<i>The appliance shall not be damaged to such an extent that compliance with this standard, in particular with Clauses 8 and 29, is impaired.</i>		N/A

Attachment 4

Main Circuit diagram

Model of appliance:

BT-B02A, BT-B02B, BT-B12A, BT-B12B, BT-B22A, BT-B22B,
BT-B32A, BT-B32B

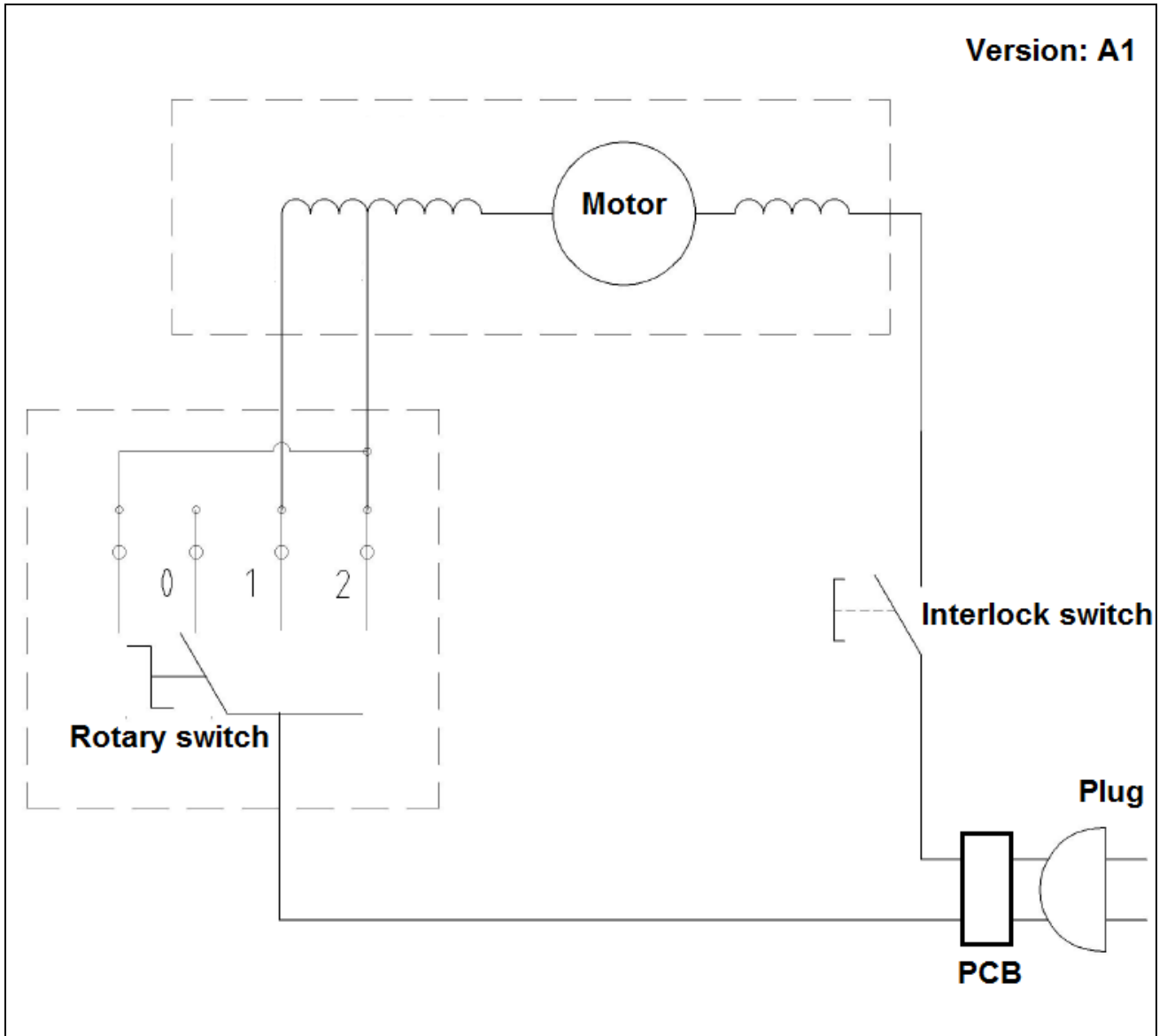

Attachment 4

Main Circuit diagram

Model of appliance:

BT-B05A, BT-B05B, BT-B15A, BT-B15B, BT-B25A, BT-B25B,
BT-B35A, BT-B35B

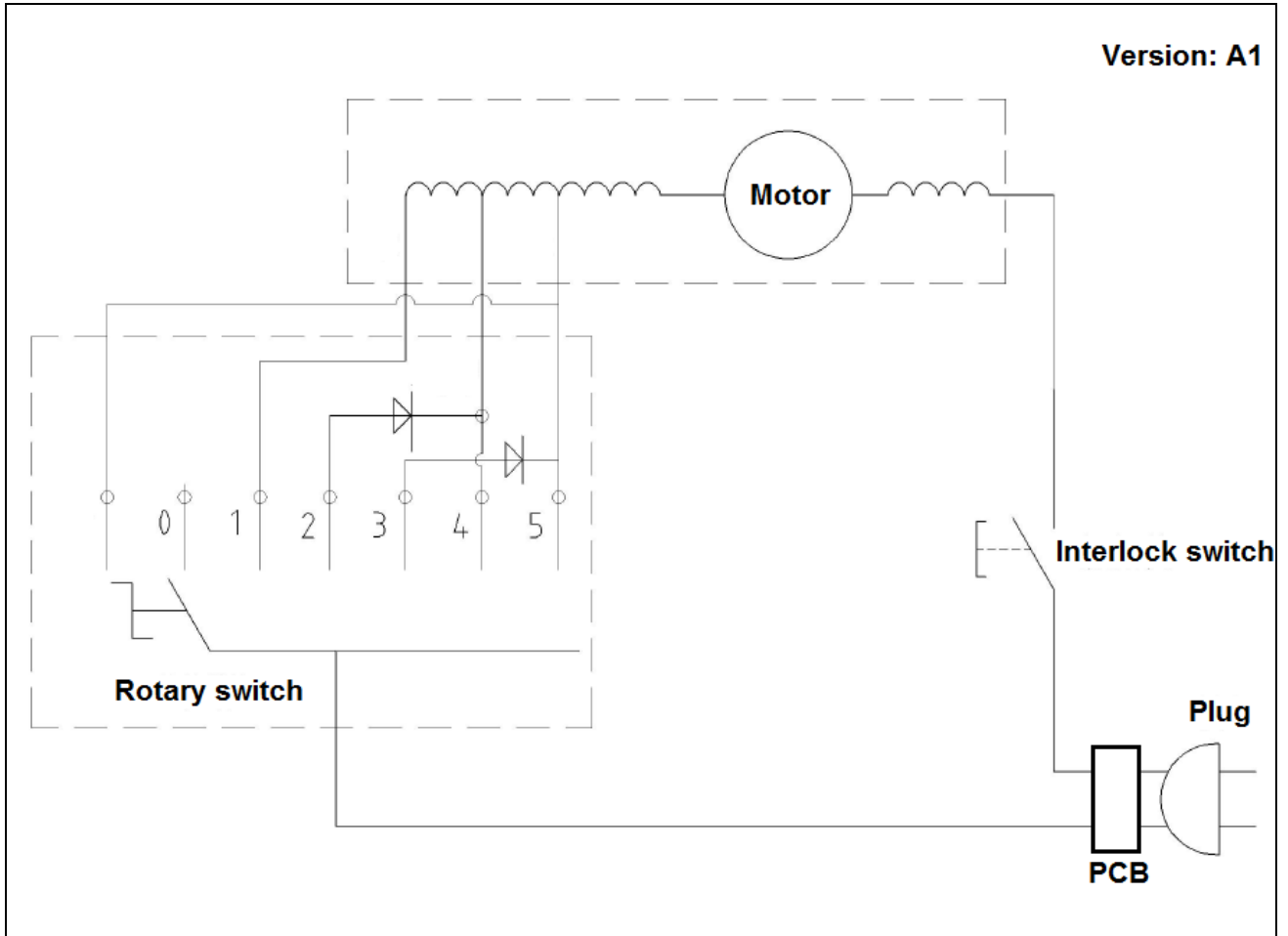

Attachment 4**PCB circuit diagram**

Model of appliance:

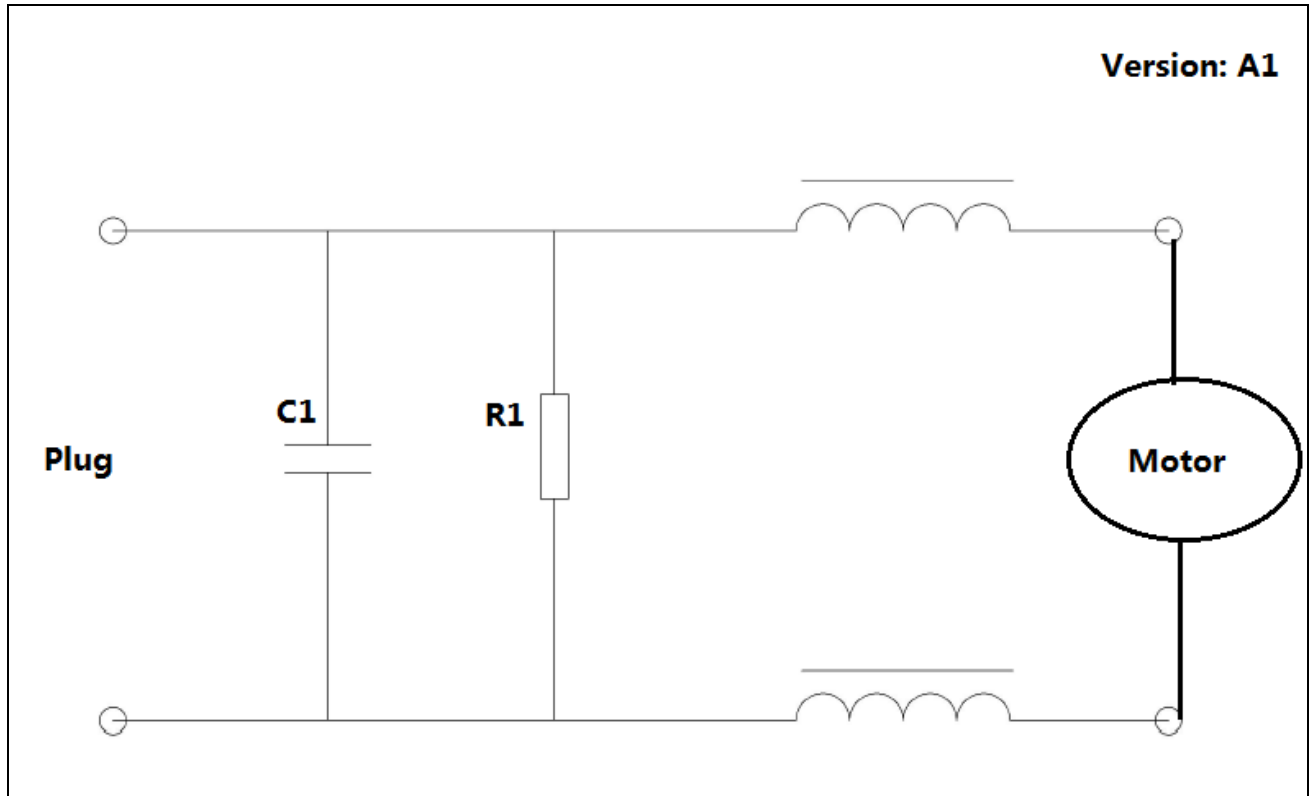
BT-B02A, BT-B02B, BT-B05A, BT-B05B, BT-B12A, BT-B12B, BT-B15A,
BT-B15B, BT-B22A, BT-B22B, BT-B25A, BT-B25B, BT-B32A, BT-B32B,
BT-B35A, BT-B35B

-- End of Attachment 4--

Attachment 5

Photo documentation

Model of appliance: BT-B02A, BT-B02B, BT-B05A, BT-B05B, BT-B12A, BT-B12B, BT-B15A, BT-B15B, BT-B22A, BT-B22B, BT-B25A, BT-B25B, BT-B32A, BT-B32B, BT-B35A, BT-B35B

Details of: Outside view of model: BT-B02A, BT-B02B

View:

- general
- front
- rear
- right
- left
- top
- bottom



Details of: Outside view of model: BT-B02A, BT-B02B

View:

- general
- front
- rear
- right
- left
- top
- bottom



Attachment 5

Details of: Outside view of model: BT-B02A, BT-B02B

View:

- general
- front
- rear
- right
- left
- top
- bottom

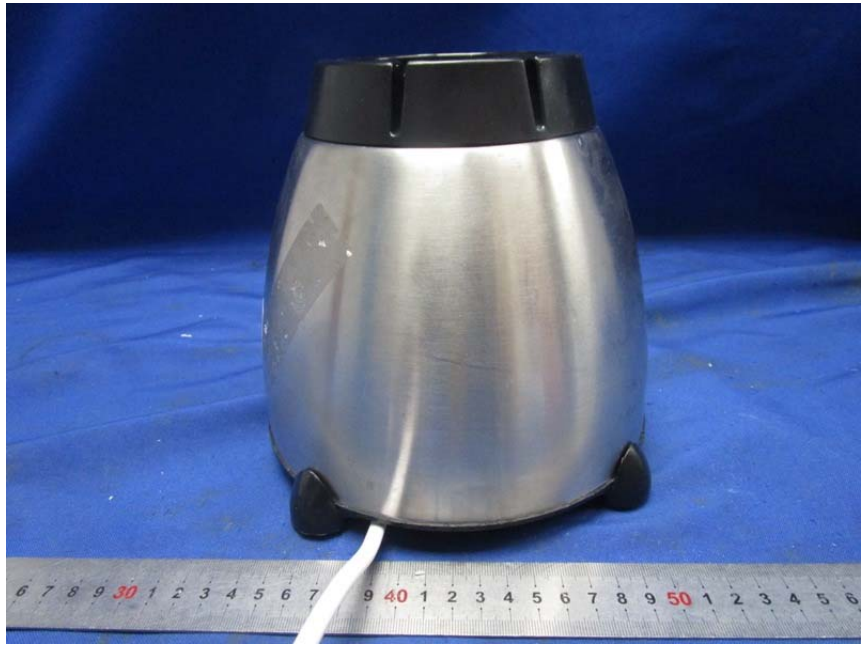

Details of: Outside view of model: BT-B02A, BT-B02B

View:

- general
- front
- rear
- right
- left
- top
- bottom

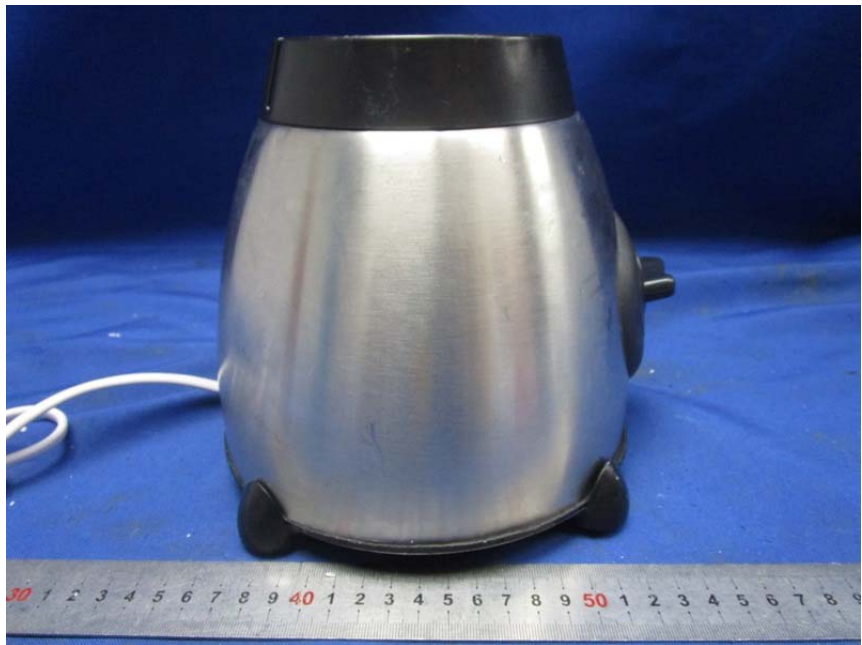

Attachment 5

Details of: Outside view of model: BT-B02A, BT-B02B

View:

- general
- front
- rear
- right
- left
- top
- bottom



Details of: Outside view of model: BT-B02A, BT-B02B

View:

- general
- front
- rear
- right
- left
- top
- bottom



Attachment 5

Details of: Outside view of model: BT-B02A, BT-B02B

View:

- general
- front
- rear
- right
- left
- top
- bottom

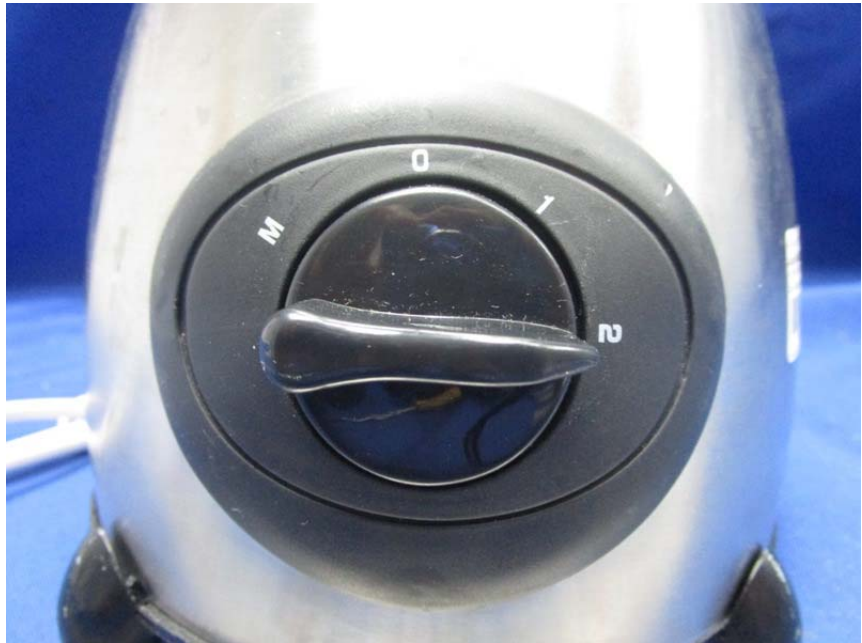

Details of: Inside view of model: BT-B02A, BT-B02B

View:

- general
- front
- rear
- right
- left
- top
- bottom

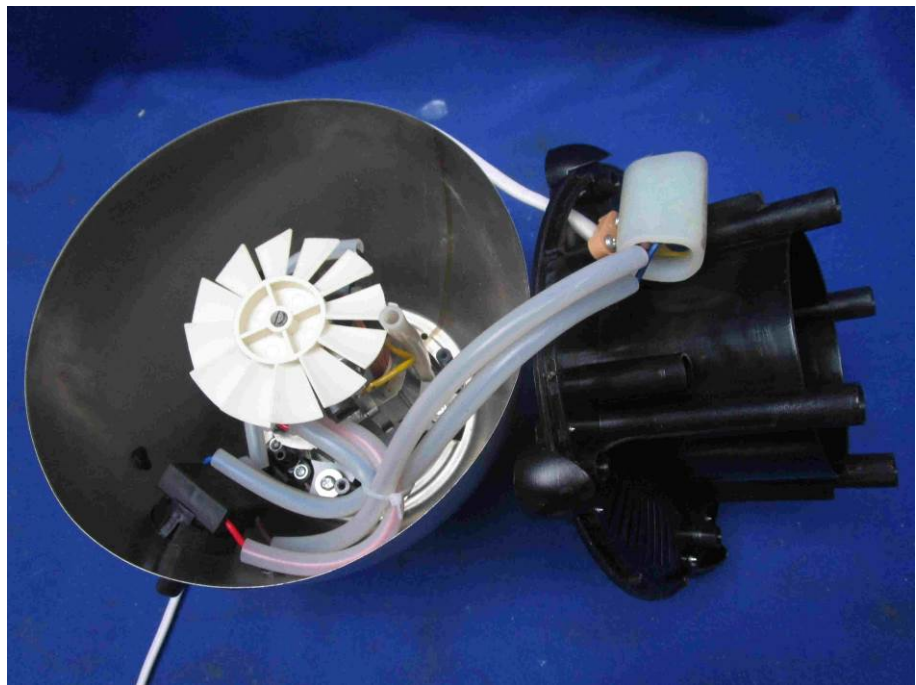

Attachment 5

Details of: Inside view of model: BT-B02A, BT-B02B

View:

- general
- front
- rear
- right
- left
- top
- bottom



Details of: Inside view of model: BT-B02A, BT-B02B

View:

- general
- front
- rear
- right
- left
- top
- bottom

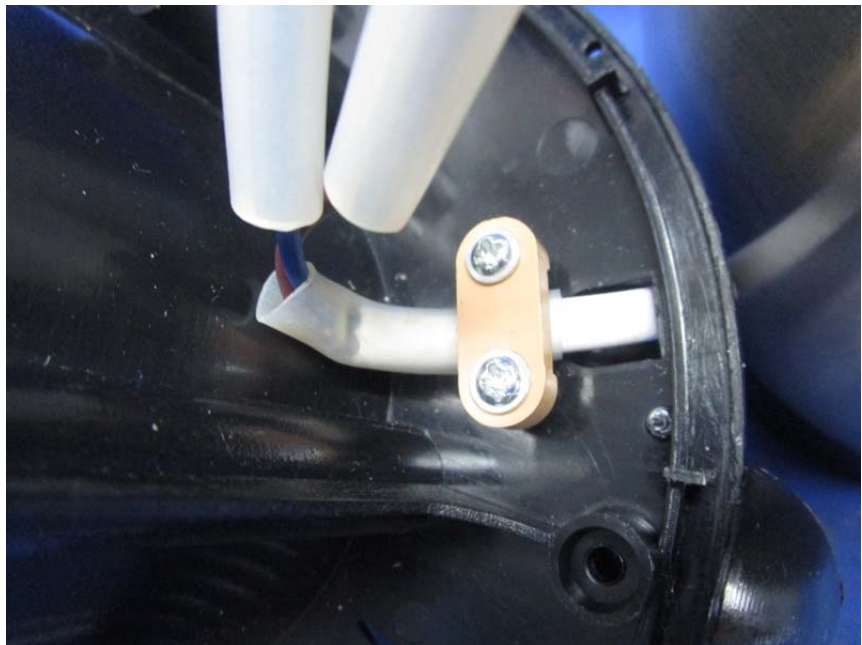

Attachment 5

Details of: Inside view of model: BT-B02A, BT-B02B

View:

- general
- front
- rear
- right
- left
- top
- bottom

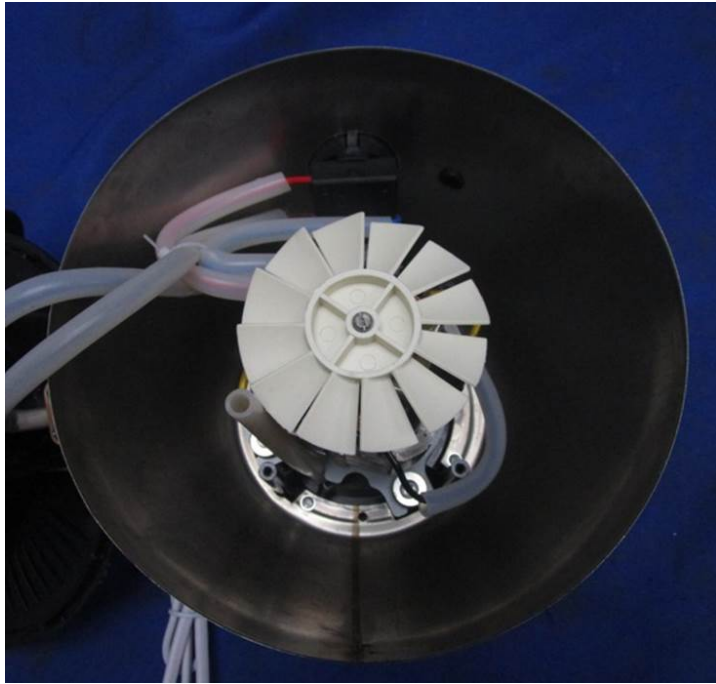

Details of: Inside view of model: BT-B02A, BT-B02B

View:

- general
- front
- rear
- right
- left
- top
- bottom

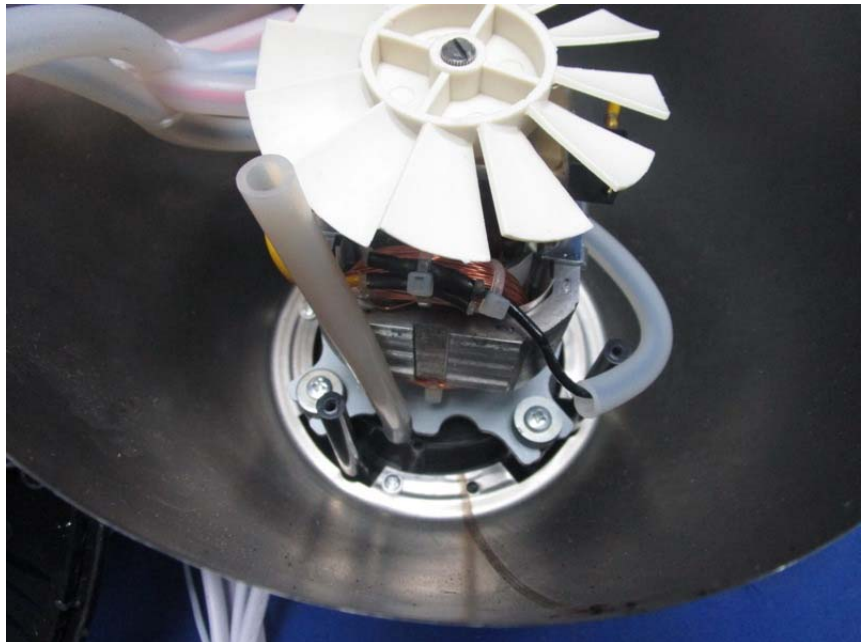

Attachment 5

Details of: Inside view of model: BT-B02A, BT-B02B

View:

- general
- front
- rear
- right
- left
- top
- bottom

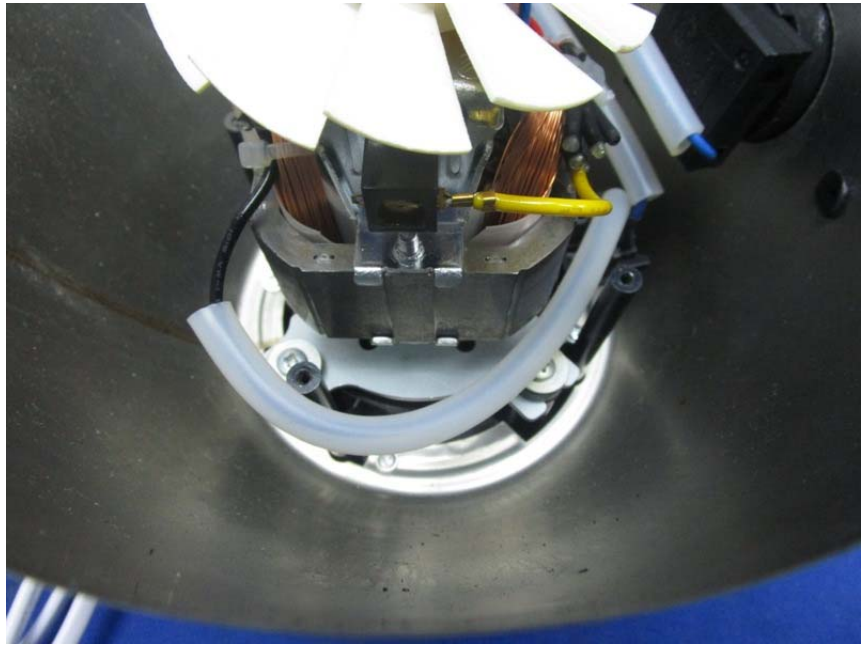

Details of: Inside view of model: BT-B02A, BT-B02B

View:

- general
- front
- rear
- right
- left
- top
- bottom

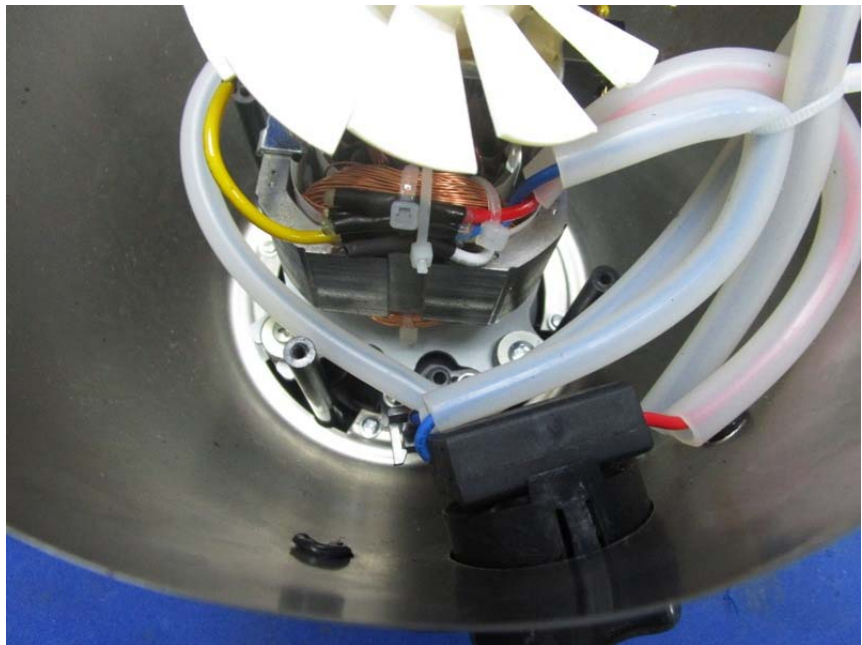

Attachment 5

Details of: Inside view of model: BT-B02A, BT-B02B

View:

- general
- front
- rear
- right
- left
- top
- bottom

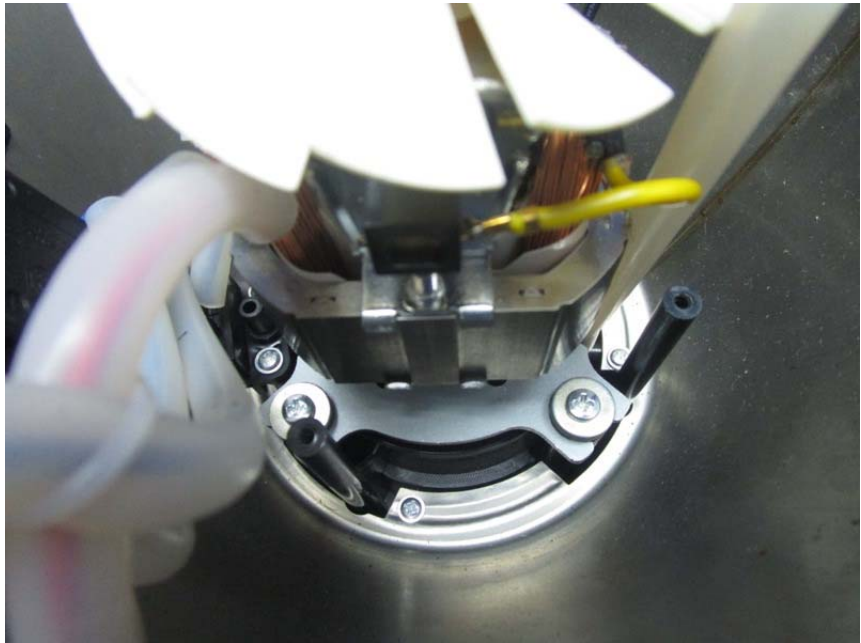

Details of: Inside view of model: BT-B02A, BT-B02B
Rotary switch, interlock switch,

View:

- general
- front
- rear
- right
- left
- top
- bottom

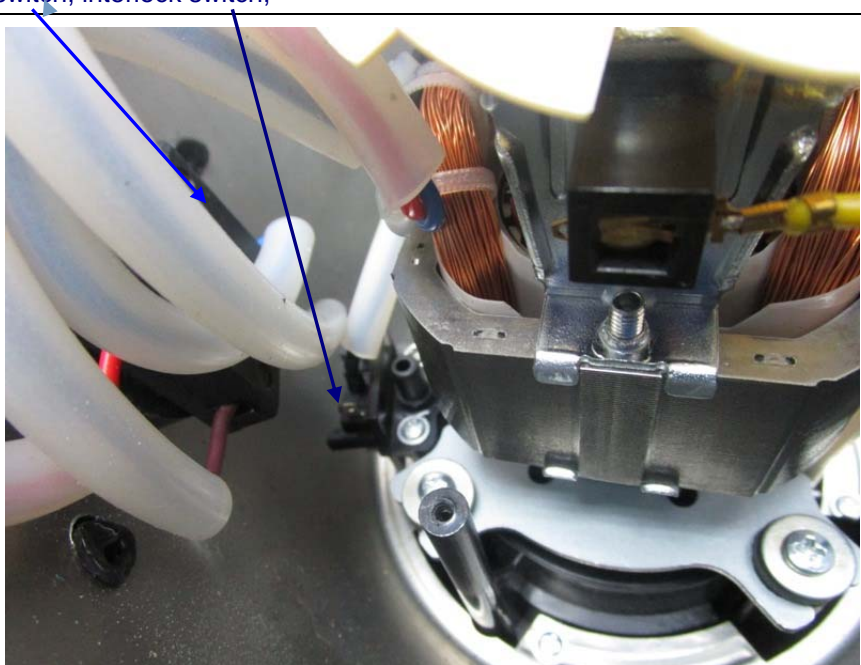

Attachment 5

Details of: Outside view of model: BT-B05A, BT-B05B

View:

- general
- front
- rear
- right
- left
- top
- bottom



Details of: Outside view of model: BT-B05A, BT-B05B

View:

- general
- front
- rear
- right
- left
- top
- bottom



Attachment 5

Details of: Outside view of model: BT-B05A, BT-B05B

View:

- general
- front
- rear
- right
- left
- top
- bottom

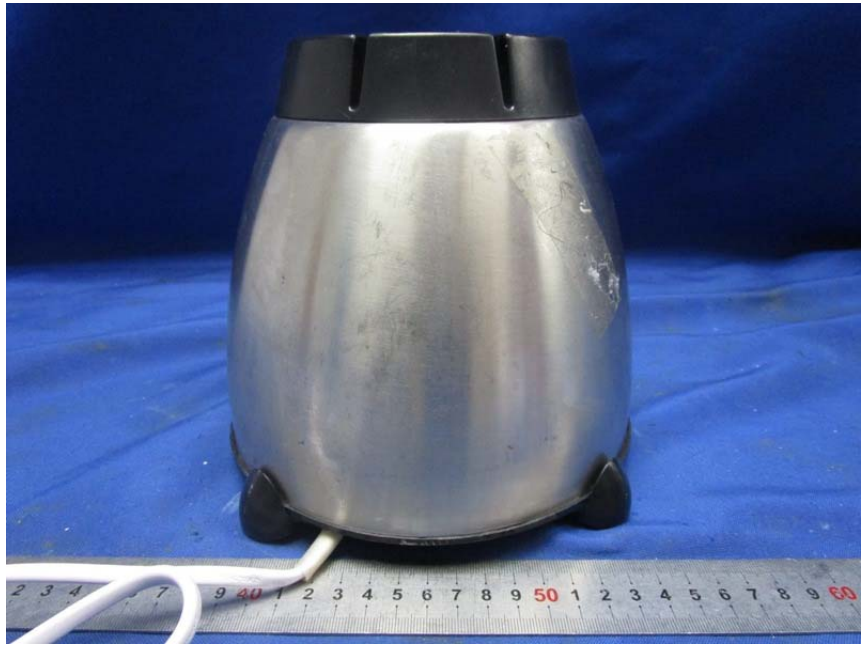

Details of: Outside view of model: BT-B05A, BT-B05B

View:

- general
- front
- rear
- right
- left
- top
- bottom



Attachment 5

Details of: Outside view of model: BT-B05A, BT-B05B

View:

- general
- front
- rear
- right
- left
- top
- bottom



Details of: Outside view of model: BT-B05A, BT-B05B

View:

- general
- front
- rear
- right
- left
- top
- bottom



Attachment 5

Details of:

Outside view of model: BT-B05A, BT-B05B
Shaft of interlock switch

View:

- general
- front
- rear
- right
- left
- top
- bottom

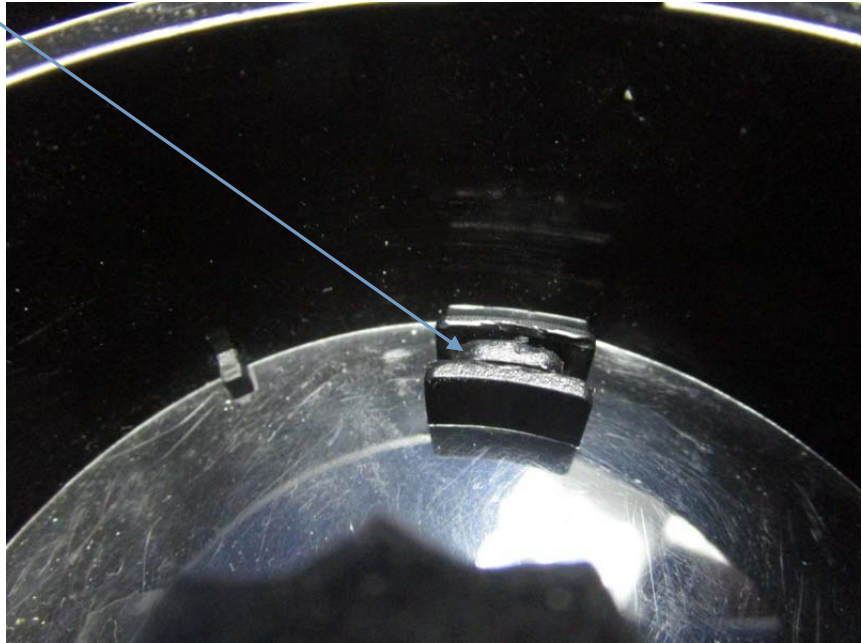

Details of:

Inside view of model: BT-B05A, BT-B05B

View:

- general
- front
- rear
- right
- left
- top
- bottom

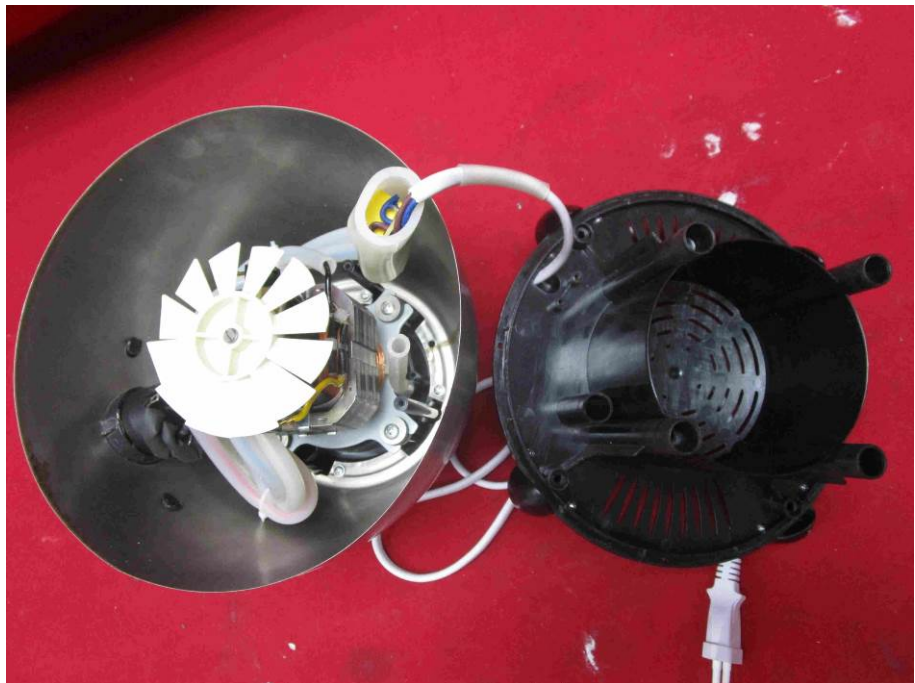

Attachment 5

Details of: Inside view of model: BT-B05A, BT-B05B

View:

- general
- front
- rear
- right
- left
- top
- bottom



Details of: Inside view of model: BT-B05A, BT-B05B

View:

- general
- front
- rear
- right
- left
- top
- bottom

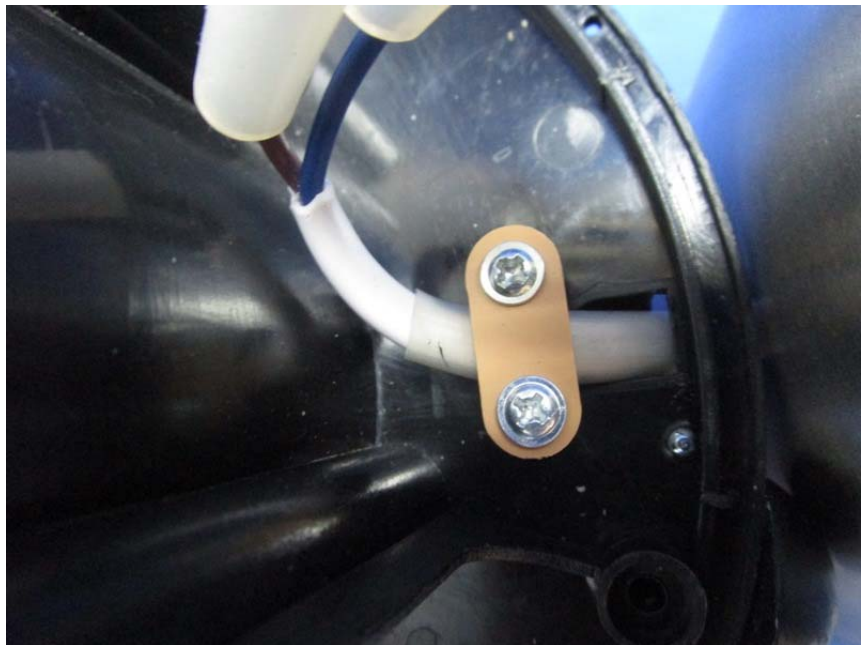

Attachment 5

Details of: Inside view of model: BT-B05A, BT-B05B

View:

- general
- front
- rear
- right
- left
- top
- bottom

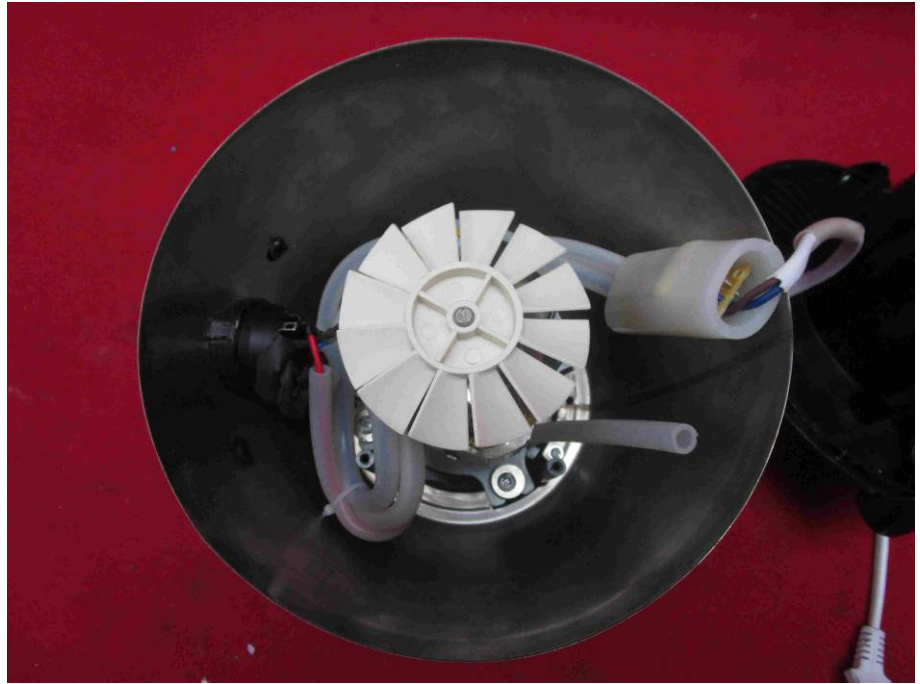

Details of: Inside view of model: BT-B05A, BT-B05B

View:

- general
- front
- rear
- right
- left
- top
- bottom

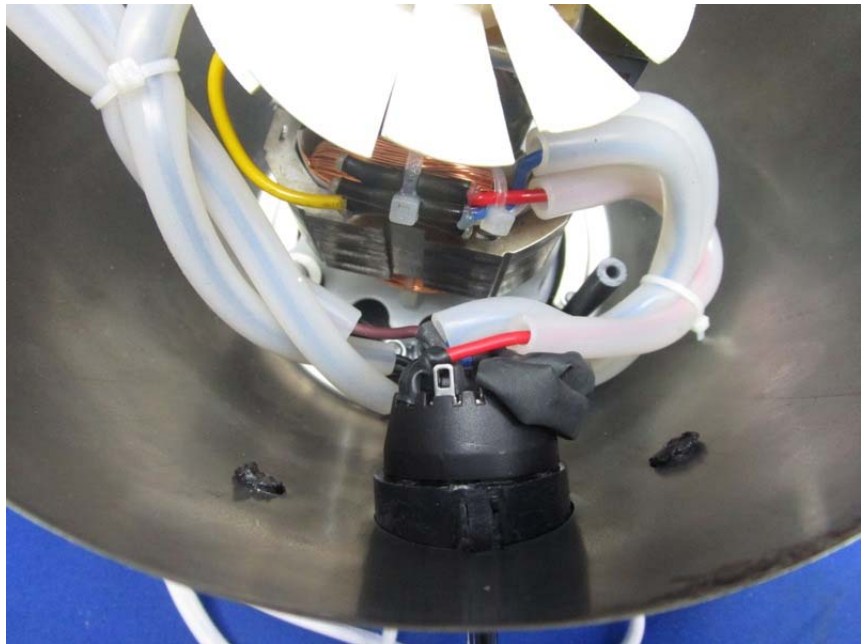

Attachment 5

Details of: Inside view of model: BT-B05A, BT-B05B

View:

- general
- front
- rear
- right
- left
- top
- bottom

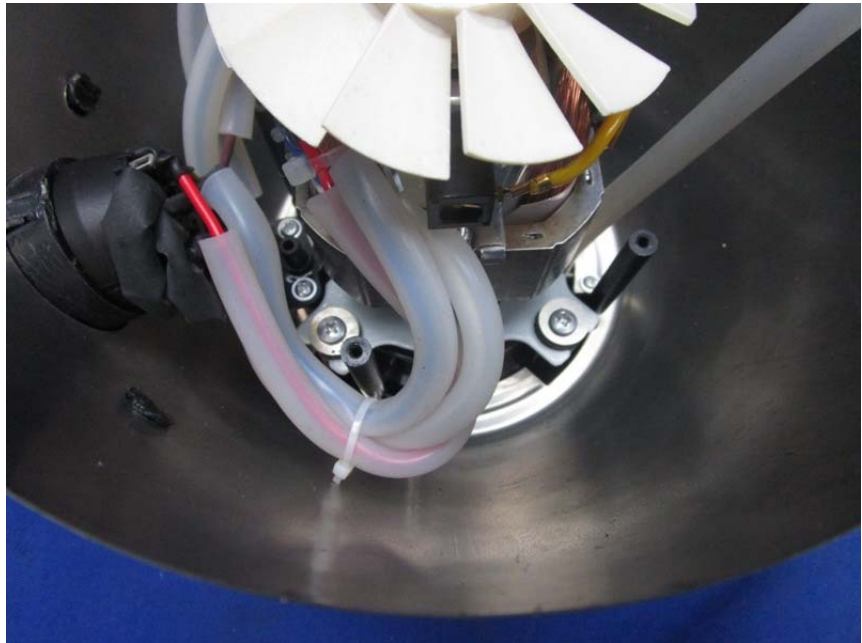

Details of: Inside view of model: BT-B05A, BT-B05B

View:

- general
- front
- rear
- right
- left
- top
- bottom

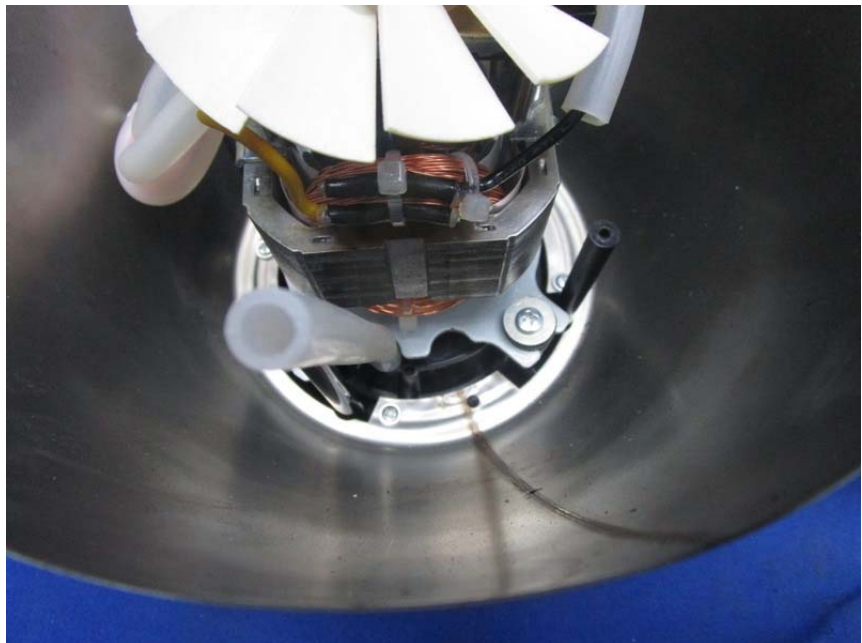

Attachment 5

Details of: Inside view of model: BT-B05A, BT-B05B

View:

- general
- front
- rear
- right
- left
- top
- bottom

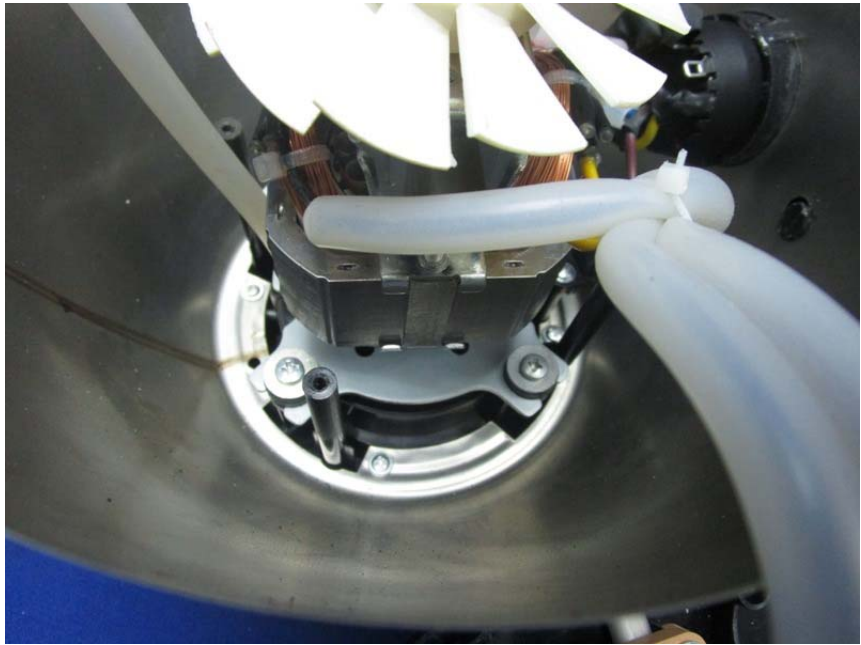

Details of: Inside view of model: BT-B05A, BT-B05B

View:

- general
- front
- rear
- right
- left
- top
- bottom

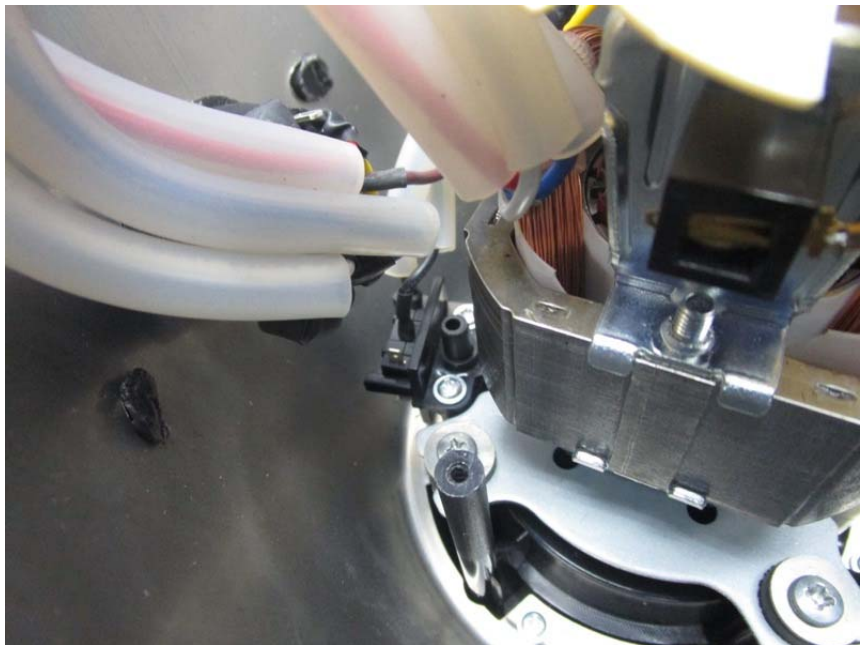

Attachment 5

Details of: Outside view of model: BT-B15A, BT-B15B

View:

- general
- front
- rear
- right
- left
- top
- bottom



Details of: Outside view of model: BT-B15A, BT-B15B

View:

- general
- front
- rear
- right
- left
- top
- bottom



Attachment 5

Details of: Outside view of model: BT-B15A, BT-B15B

View:

- general
- front
- rear
- right
- left
- top
- bottom



Details of: Outside view of model: BT-B15A, BT-B15B

View:

- general
- front
- rear
- right
- left
- top
- bottom



Attachment 5

Details of: Outside view of model: BT-B15A, BT-B15B

View:

- general
- front
- rear
- right
- left
- top
- bottom

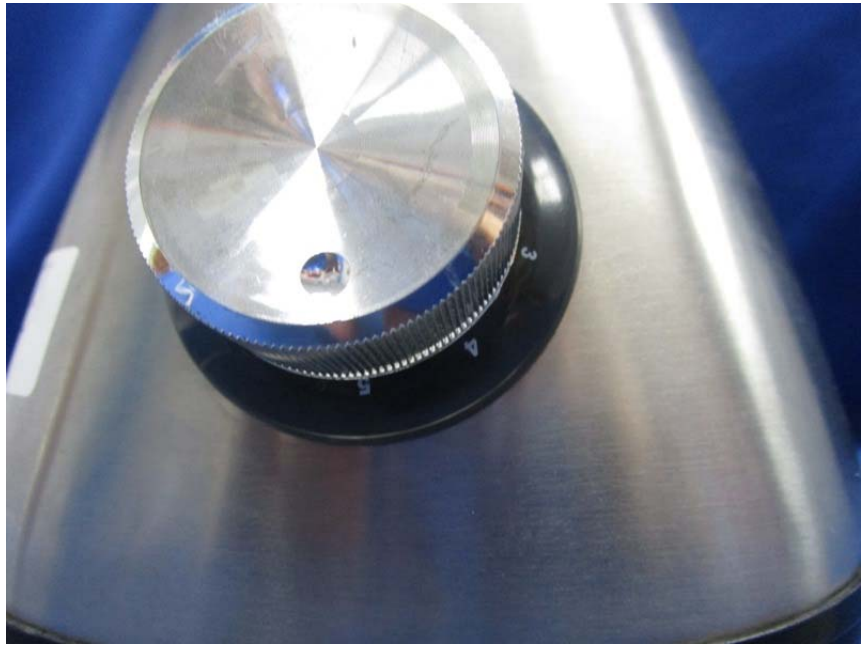

Details of: Outside view of model: BT-B15A, BT-B15B

View:

- general
- front
- rear
- right
- left
- top
- bottom

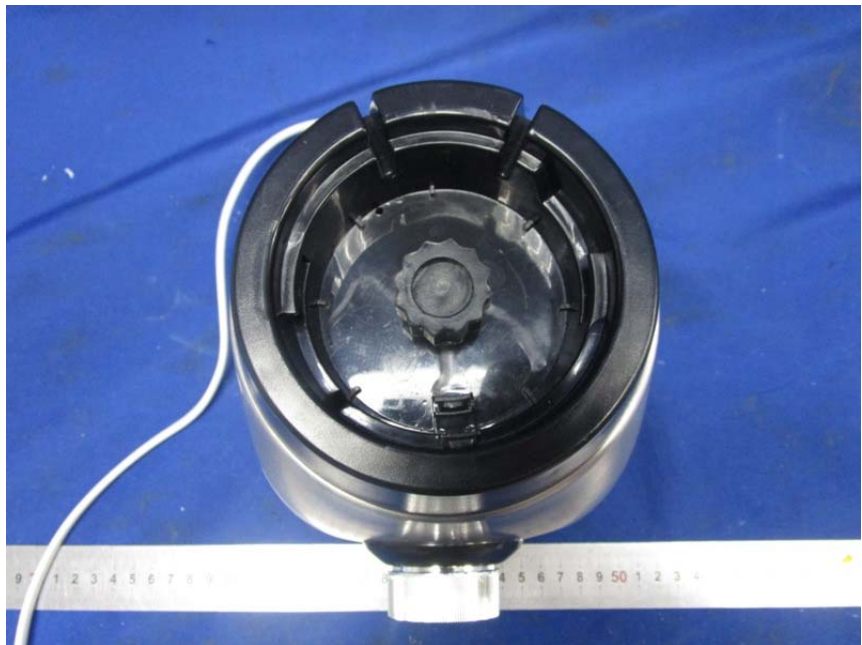

Attachment 5

Details of: Outside view of model: BT-B15A, BT-B15B

View:

- general
- front
- rear
- right
- left
- top
- bottom



Details of: Inside view of model: BT-B15A, BT-B15B

View:

- general
- front
- rear
- right
- left
- top
- bottom

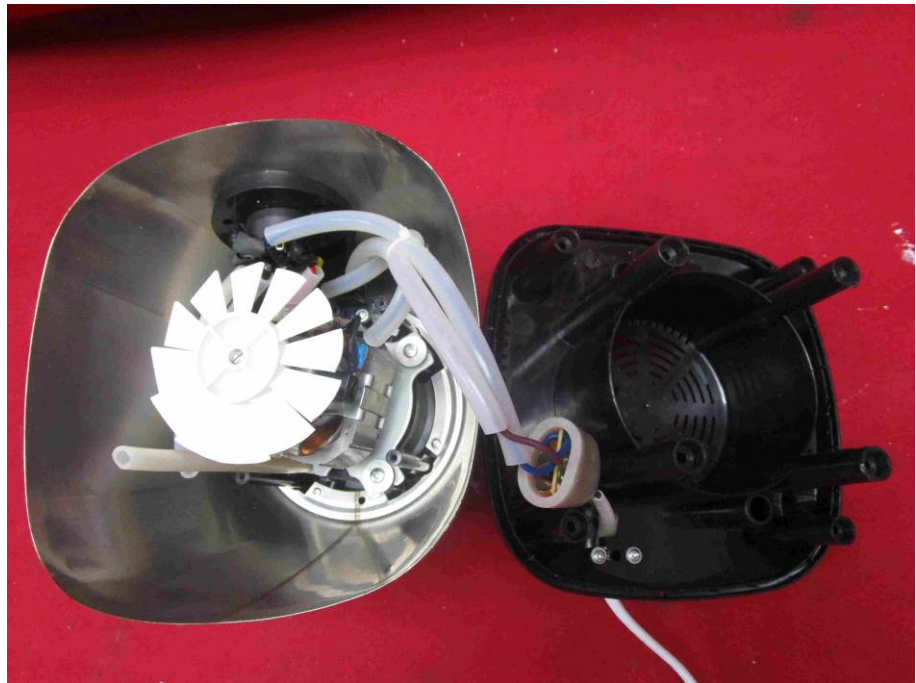

Attachment 5

Details of: Inside view of model: BT-B15A, BT-B15B

View:

- general
- front
- rear
- right
- left
- top
- bottom



Details of: Inside view of model: BT-B15A, BT-B15B

View:

- general
- front
- rear
- right
- left
- top
- bottom

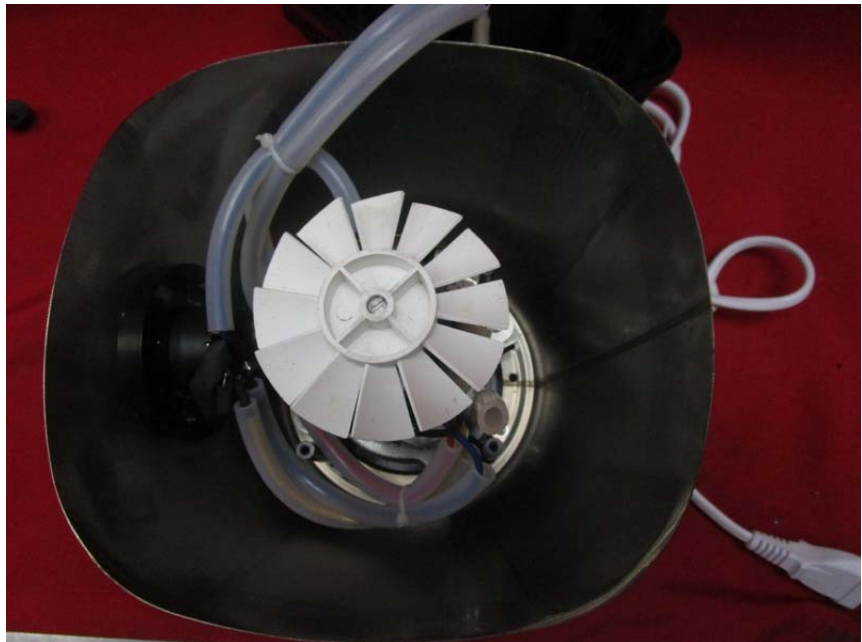

Attachment 5

Details of: Inside view of model: BT-B15A, BT-B15B

View:

- general
- front
- rear
- right
- left
- top
- bottom

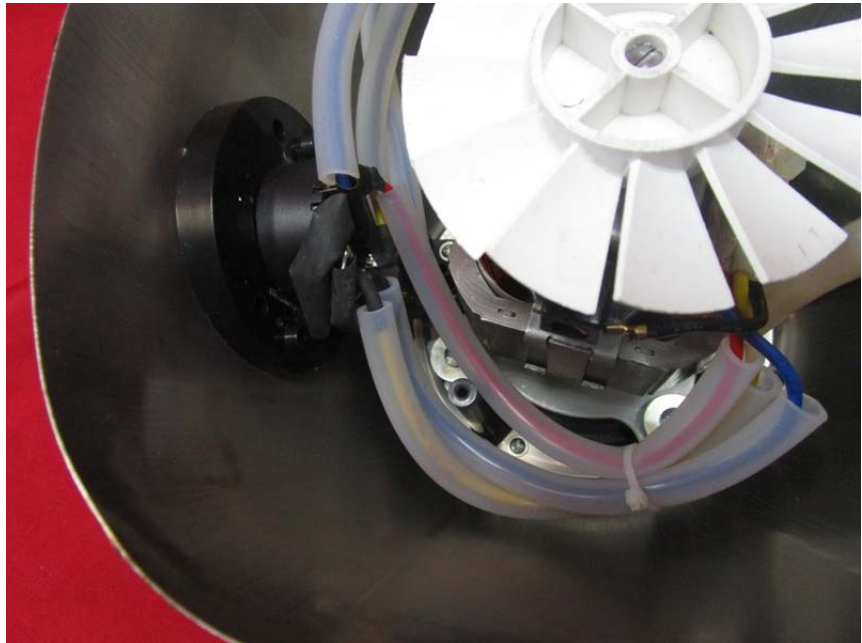

Details of: Inside view of model: BT-B15A, BT-B15B

View:

- general
- front
- rear
- right
- left
- top
- bottom

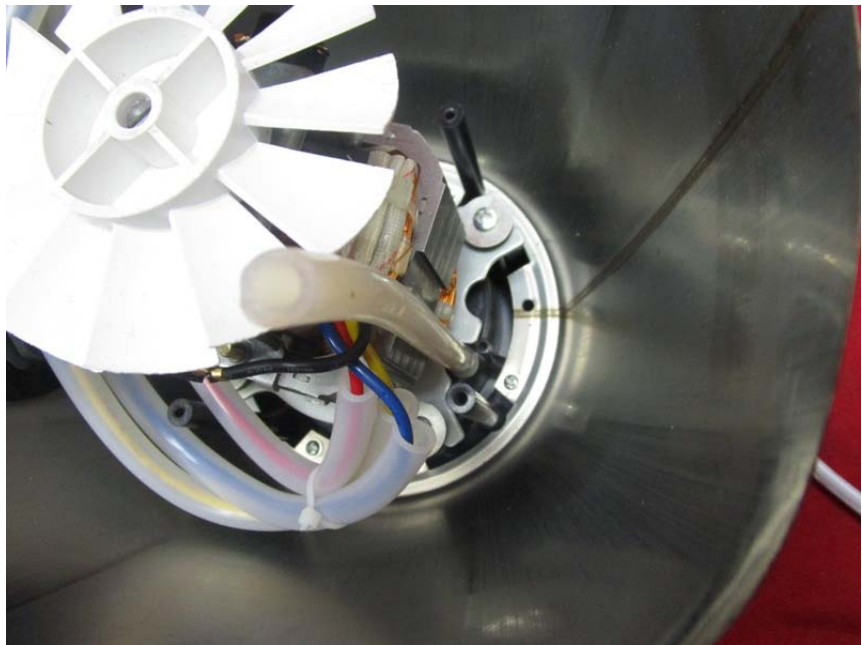

Attachment 5

Details of: Inside view of model: BT-B15A, BT-B15B

View:

- general
- front
- rear
- right
- left
- top
- bottom

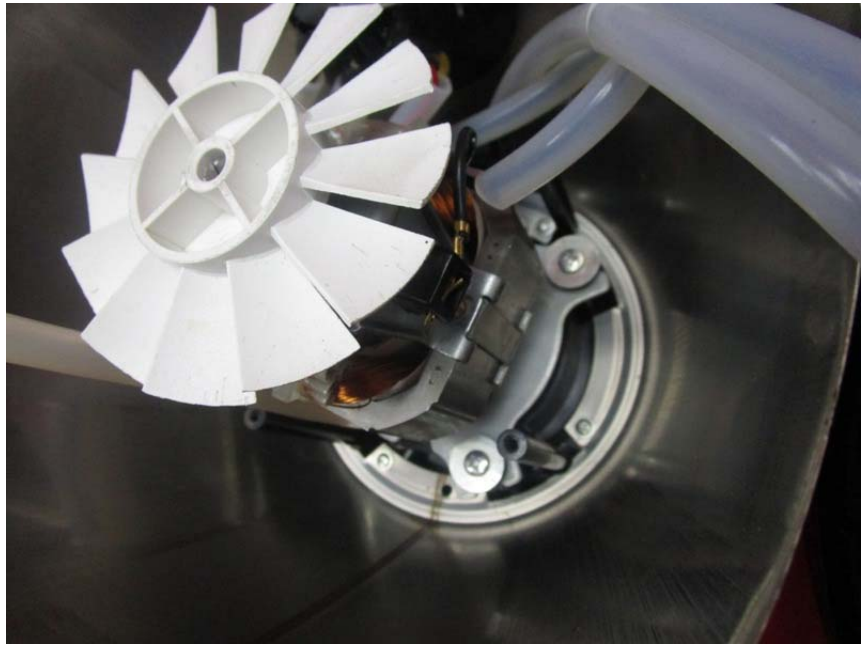

Details of: Inside view of model: BT-B15A, BT-B15B

View:

- general
- front
- rear
- right
- left
- top
- bottom

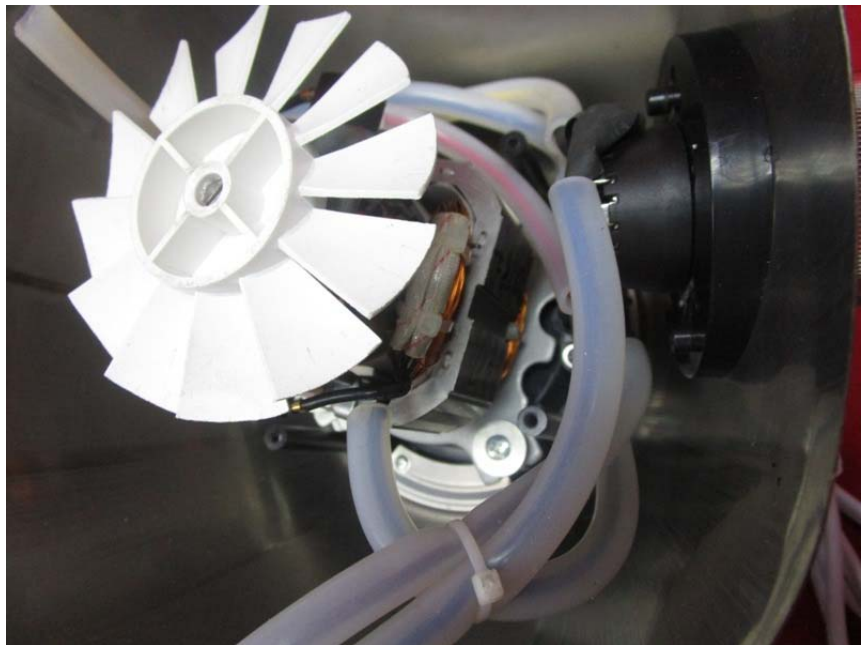

Attachment 5

Details of: Outside view of model: BT-B25A, BT-B25B

View:

- general
- front
- rear
- right
- left
- top
- bottom



Details of: Outside view of model: BT-B25A, BT-B25B

View:

- general
- front
- rear
- right
- left
- top
- bottom

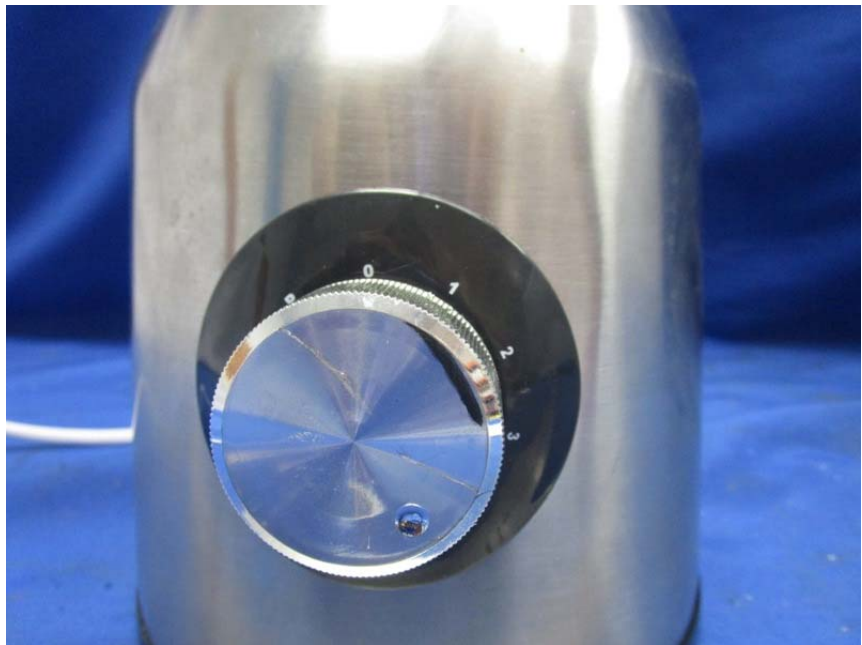

Attachment 5

Details of: Outside view of model: BT-B25A, BT-B25B

View:

- general
- front
- rear
- right
- left
- top
- bottom



Details of: Outside view of model: BT-B25A, BT-B25B

View:

- general
- front
- rear
- right
- left
- top
- bottom



Attachment 5

Details of: Outside view of model: BT-B25A, BT-B25B

View:

- general
- front
- rear
- right
- left
- top
- bottom



Details of: Outside view of model: BT-B25A, BT-B25B

View:

- general
- front
- rear
- right
- left
- top
- bottom



Attachment 5

Details of: Outside view of model: BT-B25A, BT-B25B

View:

- general
- front
- rear
- right
- left
- top
- bottom



Details of: Inside view of model: BT-B25A, BT-B25B

View:

- general
- front
- rear
- right
- left
- top
- bottom



Attachment 5

Details of: Inside view of model: BT-B25A, BT-B25B

View:

- general
- front
- rear
- right
- left
- top
- bottom



Attachment 5

Details of: Inside view of model: BT-B25A, BT-B25B

View:

- general
- front
- rear
- right
- left
- top
- bottom

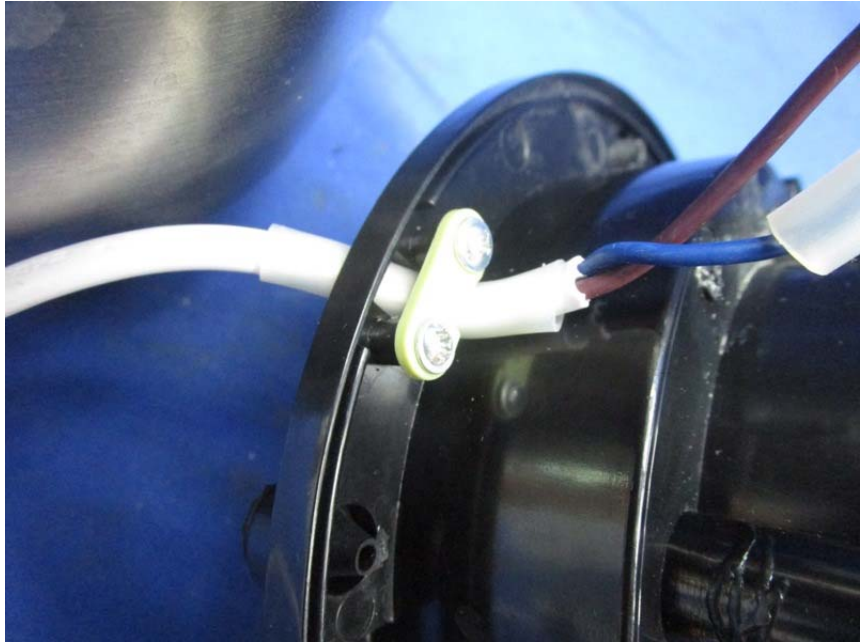

Details of: Inside view of model: BT-B25A, BT-B25B

View:

- general
- front
- rear
- right
- left
- top
- bottom

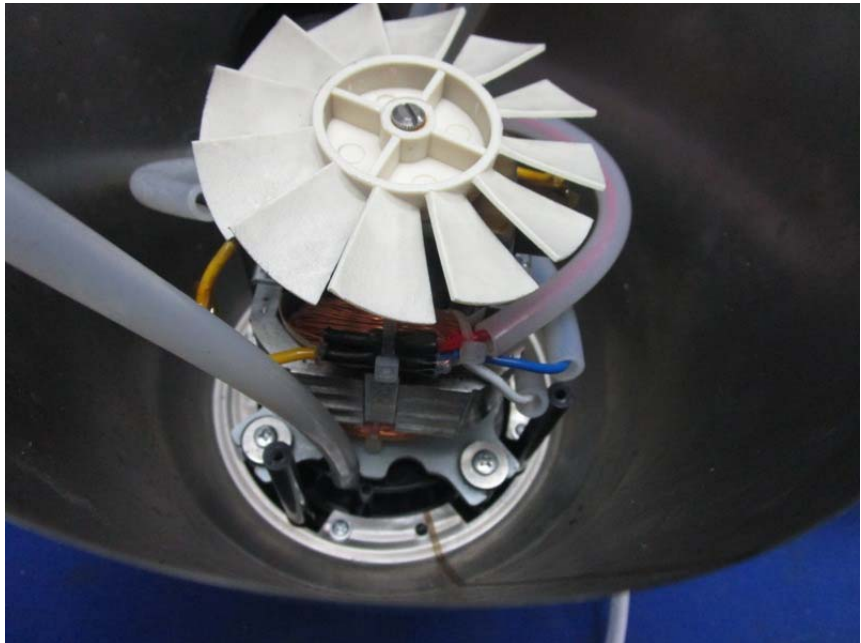

Attachment 5

Details of: Inside view of model: BT-B25A, BT-B25B

View:

- general
- front
- rear
- right
- left
- top
- bottom



Details of: Inside view of model: BT-B25A, BT-B25B

View:

- general
- front
- rear
- right
- left
- top
- bottom



Attachment 5

Details of: Inside view of model: BT-B25A, BT-B25B

View:

- general
- front
- rear
- right
- left
- top
- bottom

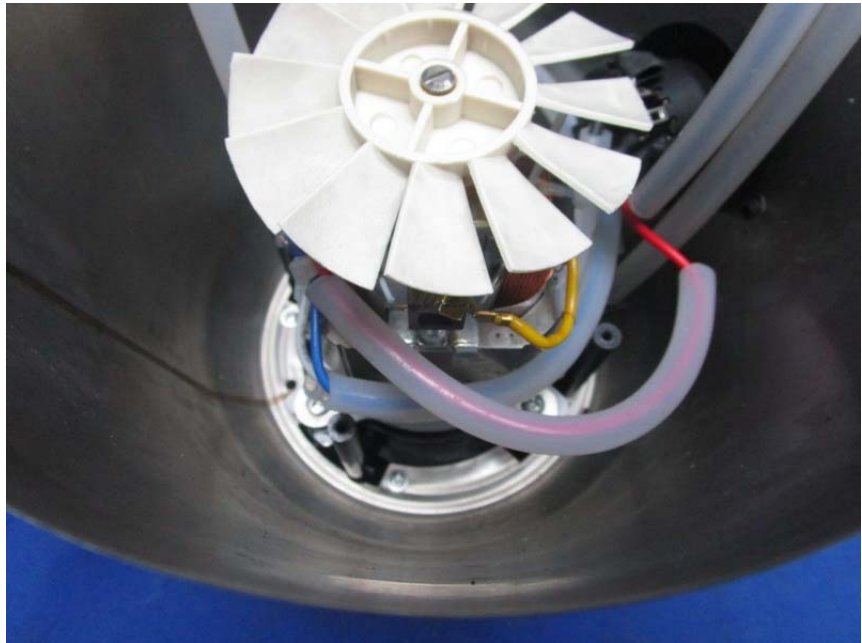

Details of: Inside view of model: BT-B25A, BT-B25B

View:

- general
- front
- rear
- right
- left
- top
- bottom

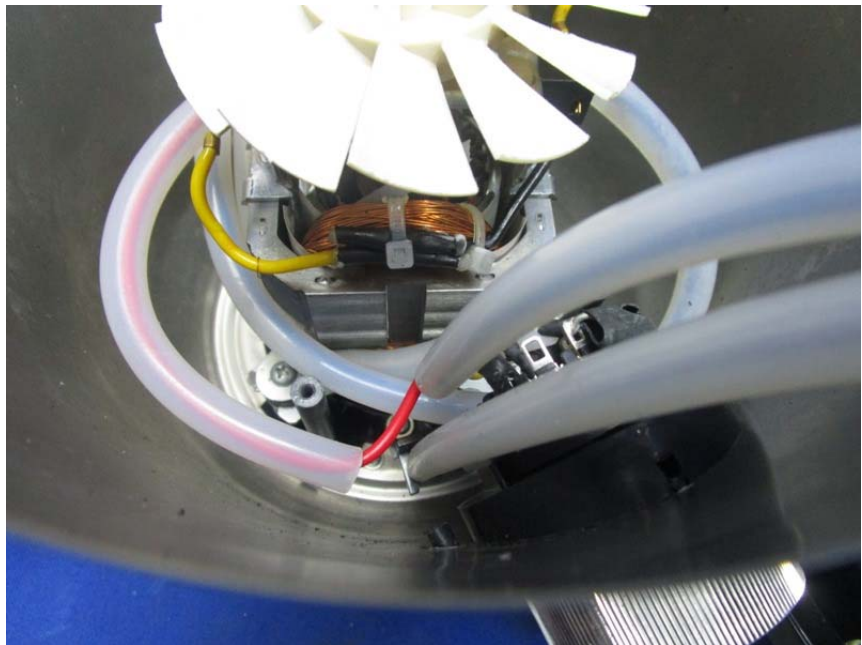

Attachment 5

Details of: Inside view of model: BT-B25A, BT-B25B

View:

- general
- front
- rear
- right
- left
- top
- bottom



Details of: Outside view of model: BT-B32A, BT-B32B

View:

- general
- front
- rear
- right
- left
- top
- bottom



Attachment 5

Details of: Outside view of model: BT-B32A, BT-B32B

View:

- general
- front
- rear
- right
- left
- top
- bottom



Details of: Outside view of model: BT-B32A, BT-B32B

View:

- general
- front
- rear
- right
- left
- top
- bottom

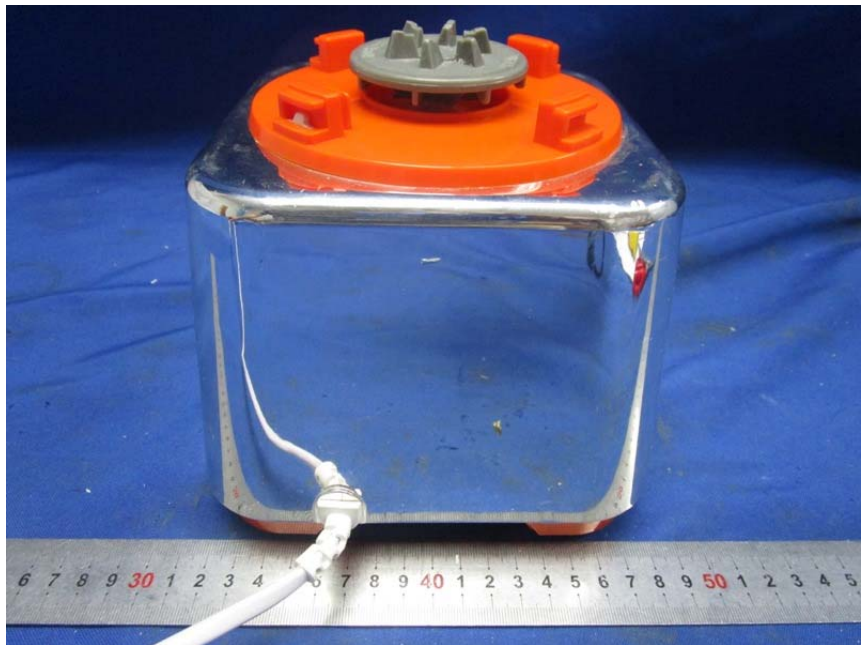

Attachment 5

Details of: Outside view of model: BT-B32A, BT-B32B

View:

- general
- front
- rear
- right
- left
- top
- bottom



Details of: Outside view of model: BT-B32A, BT-B32B

View:

- general
- front
- rear
- right
- left
- top
- bottom

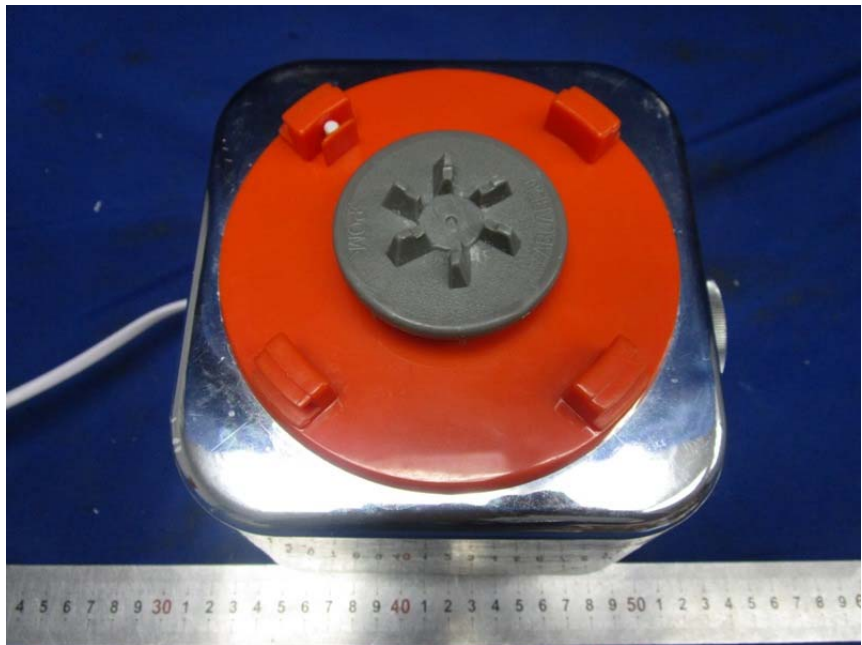

Attachment 5

Details of: Outside view of model: BT-B32A, BT-B32B

View:

- general
- front
- rear
- right
- left
- top
- bottom

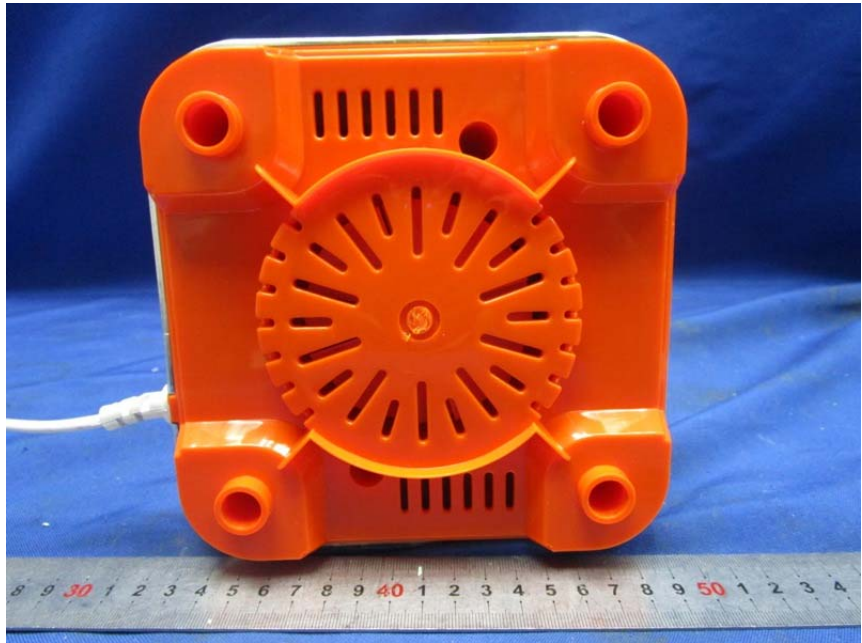

Details of: Outside view of model: BT-B32A, BT-B32B

View:

- general
- front
- rear
- right
- left
- top
- bottom

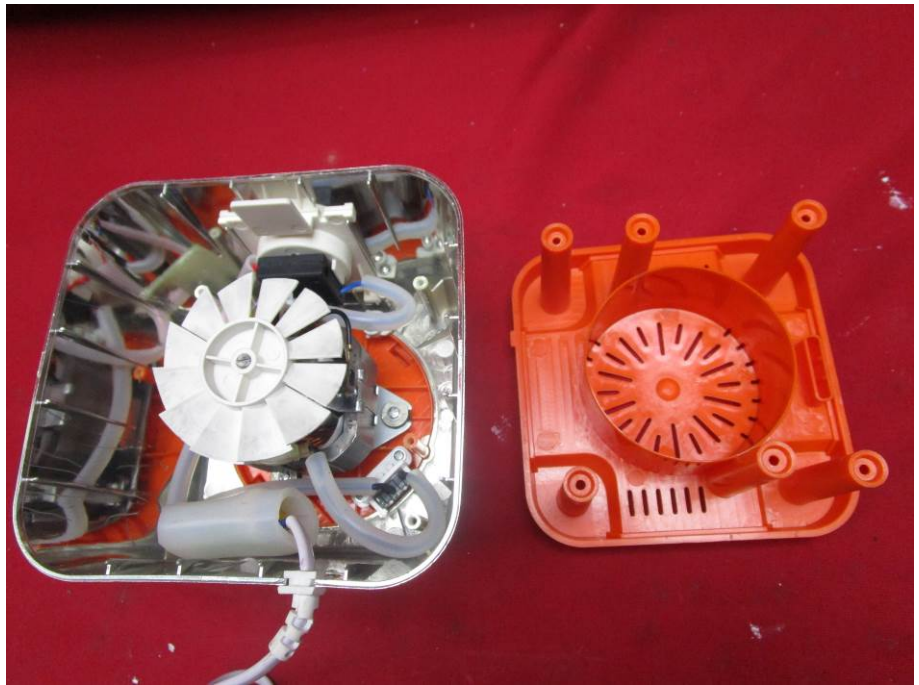

Attachment 5

Details of: Inside view of model: BT-B32A, BT-B32B

View:

- general
- front
- rear
- right
- left
- top
- bottom

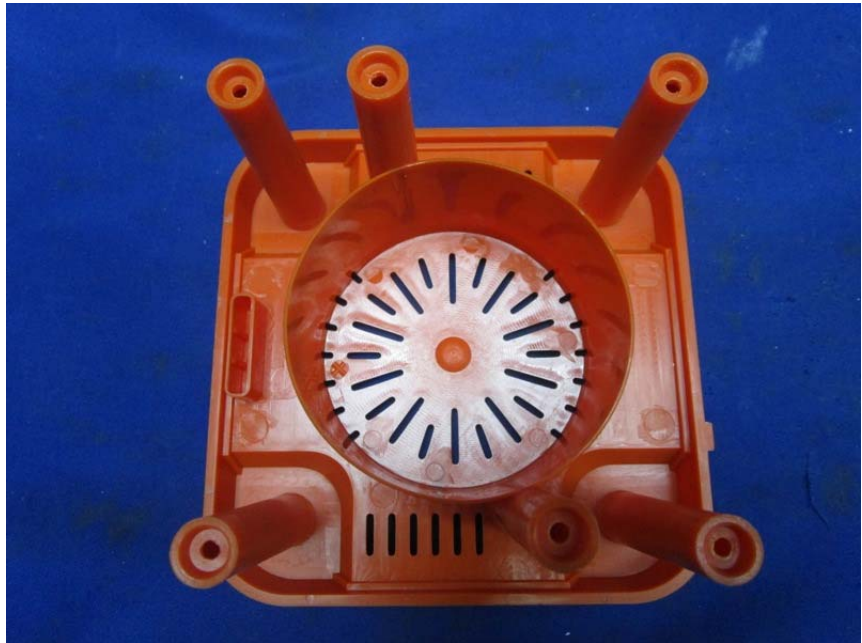

Details of: Inside view of model: BT-B32A, BT-B32B

View:

- general
- front
- rear
- right
- left
- top
- bottom

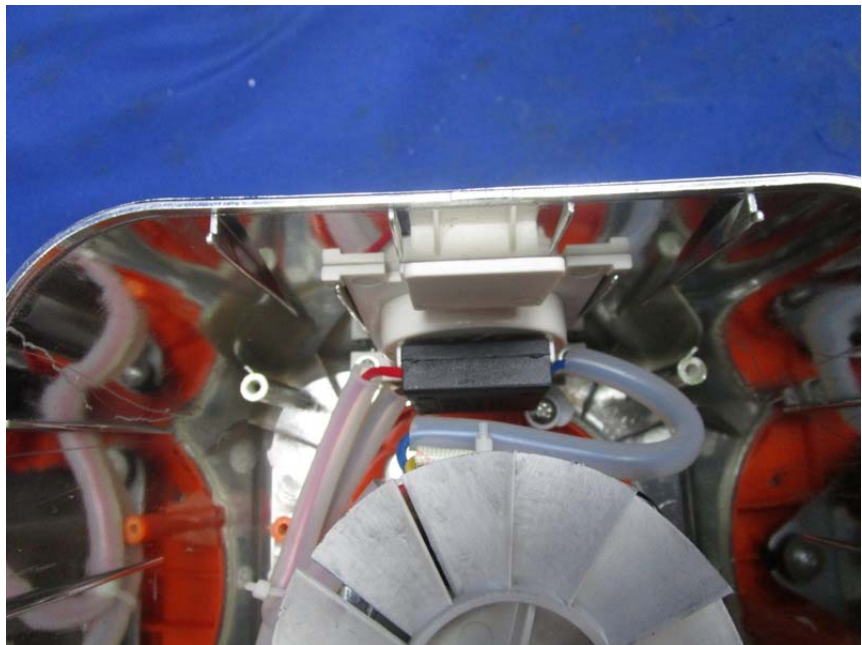

Attachment 5

Details of: Inside view of model: BT-B32A, BT-B32B

View:

- general
- front
- rear
- right
- left
- top
- bottom

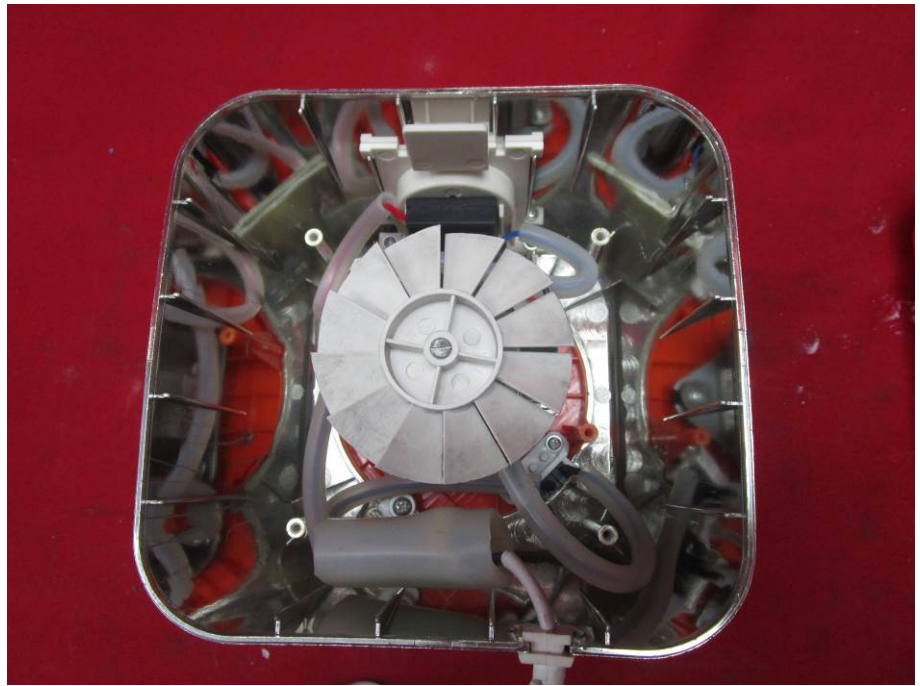

Details of: Inside view of model: BT-B32A, BT-B32B

View:

- general
- front
- rear
- right
- left
- top
- bottom

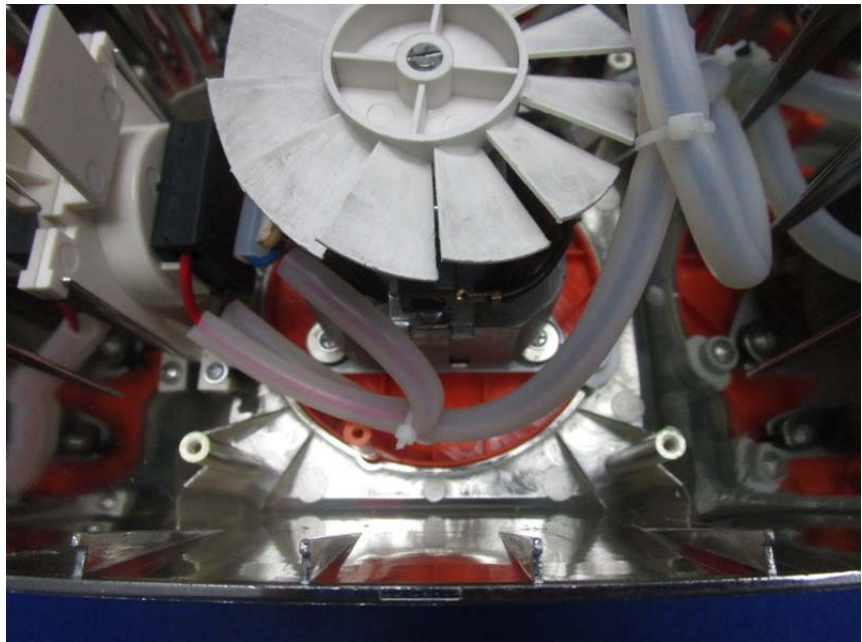

Attachment 5

Details of: Inside view of model: BT-B32A, BT-B32B

View:

- general
- front
- rear
- right
- left
- top
- bottom

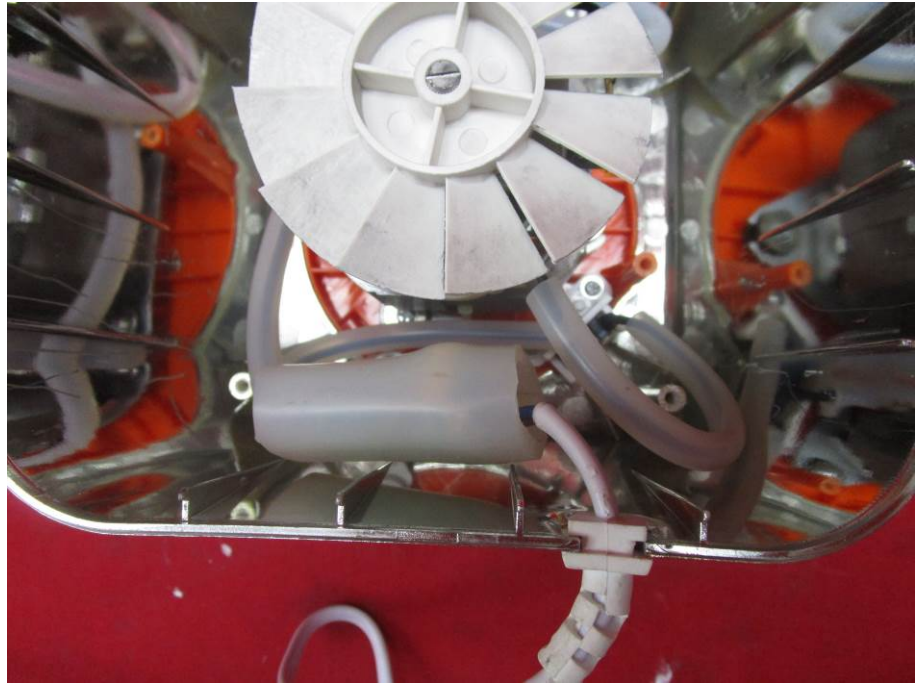

Details of: Inside view of model: BT-B32A, BT-B32B

View:

- general
- front
- rear
- right
- left
- top
- bottom

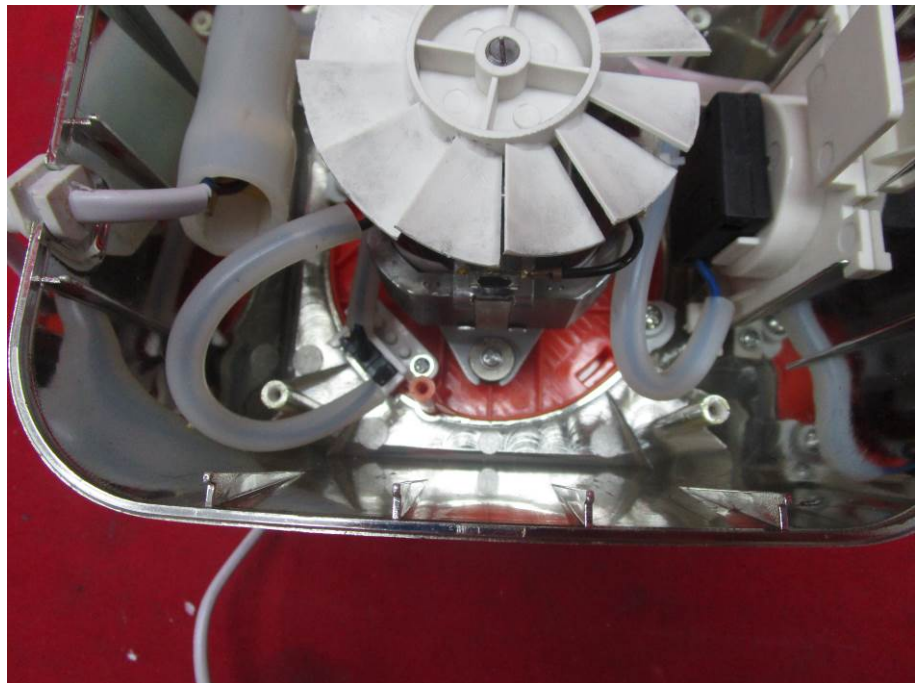

Attachment 5

Details of: Inside view of model: BT-B32A, BT-B32B

View:

- general
- front
- rear
- right
- left
- top
- bottom

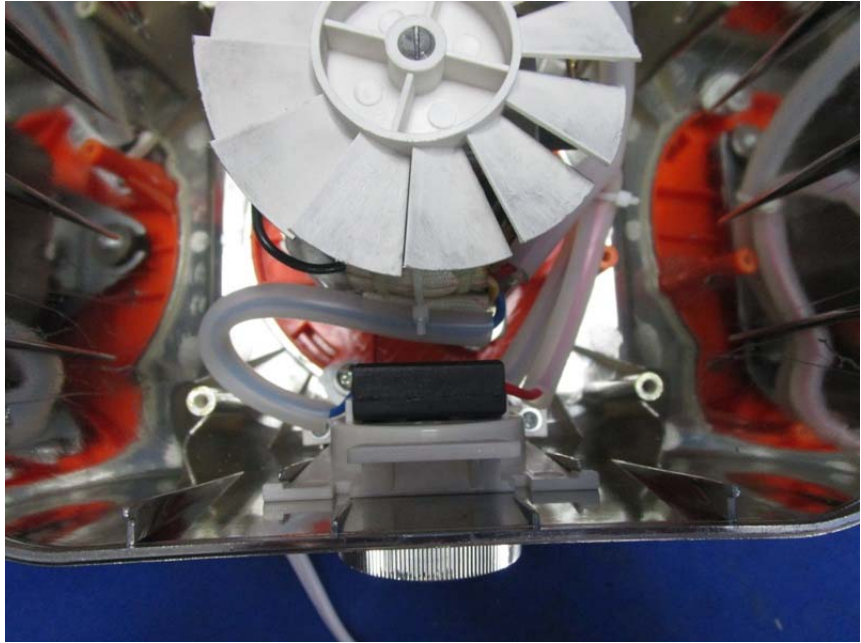

Details of: Outside view of model: BT-B12A, BT-B12B

View:

- general
- front
- rear
- right
- left
- top
- bottom

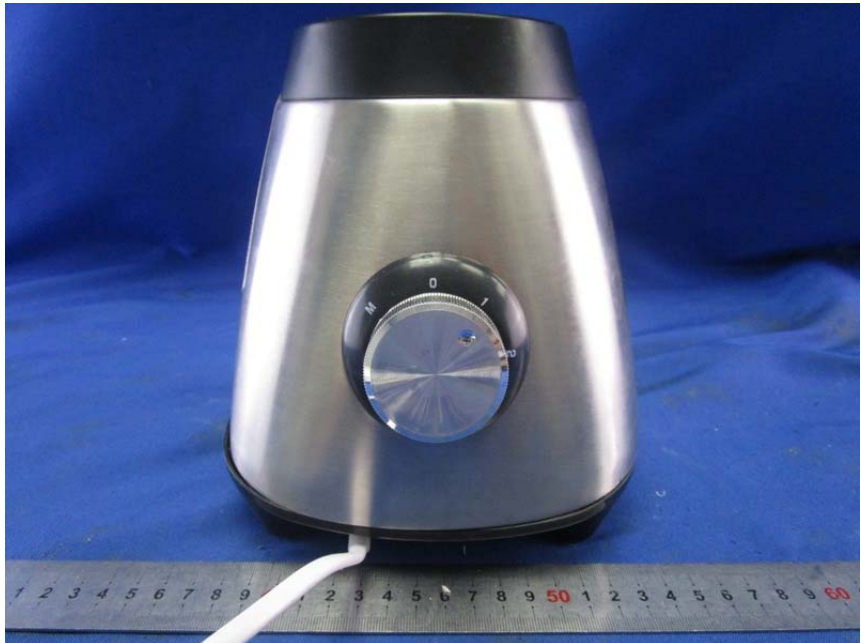

Attachment 5

Details of: Outside view of model: BT-B12A, BT-B12B

View:

- general
- front
- rear
- right
- left
- top
- bottom



Details of: Outside view of model: BT-B12A, BT-B12B

View:

- general
- front
- rear
- right
- left
- top
- bottom



Attachment 5

Details of: Outside view of model: BT-B12A, BT-B12B

View:

- general
- front
- rear
- right
- left
- top
- bottom



Details of: Outside view of model: BT-B12A, BT-B12B

View:

- general
- front
- rear
- right
- left
- top
- bottom



Attachment 5

Details of: Outside view of model: BT-B12A, BT-B12B

View:

- general
- front
- rear
- right
- left
- top
- bottom



Details of: Outside view of model: BT-B12A, BT-B12B

View:

- general
- front
- rear
- right
- left
- top
- bottom



Attachment 5

Details of: Inside view of model: BT-B12A, BT-B12B

View:

- general
- front
- rear
- right
- left
- top
- bottom

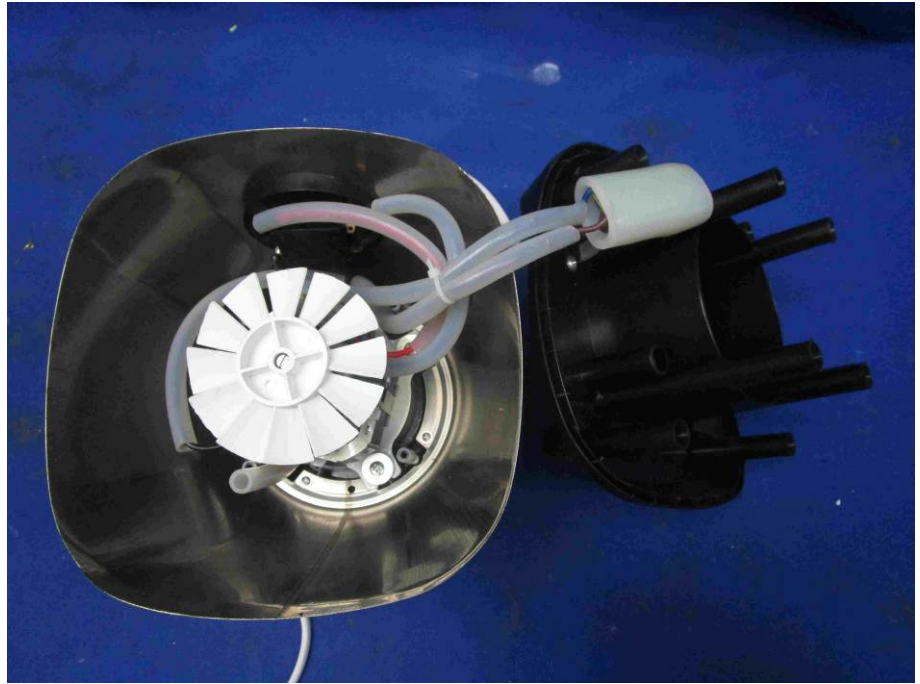

Details of: Inside view of model: BT-B12A, BT-B12B

View:

- general
- front
- rear
- right
- left
- top
- bottom



Attachment 5

Details of: Inside view of model: BT-B12A, BT-B12B

View:

- general
- front
- rear
- right
- left
- top
- bottom

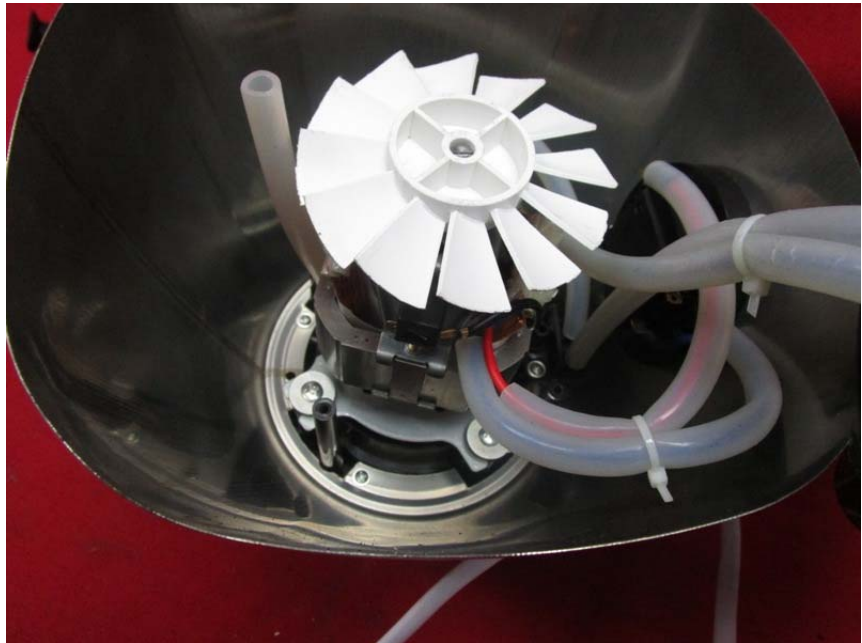

Details of: Inside view of model: BT-B12A, BT-B12B

View:

- general
- front
- rear
- right
- left
- top
- bottom

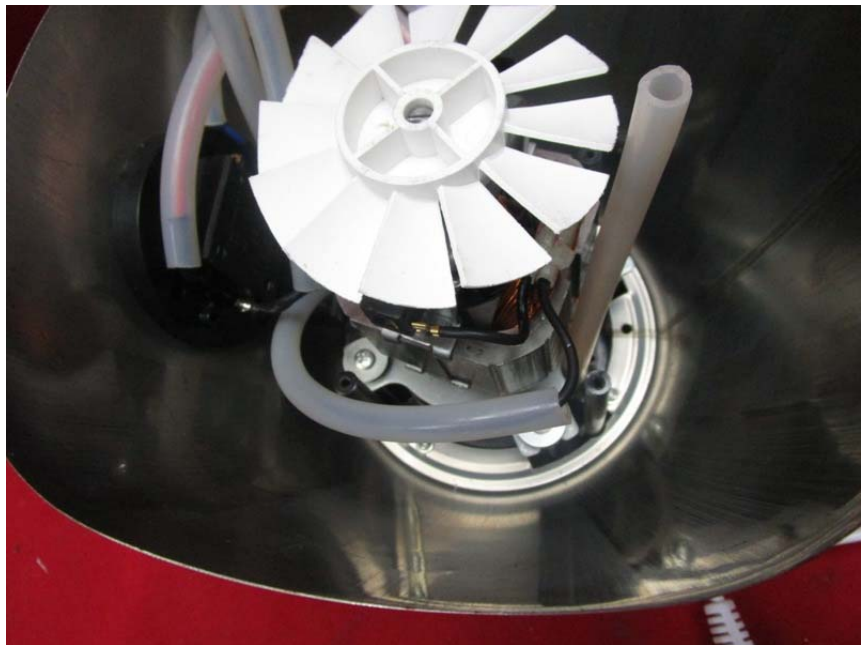

Attachment 5

Details of: Inside view of model: BT-B12A, BT-B12B

View:

- general
- front
- rear
- right
- left
- top
- bottom

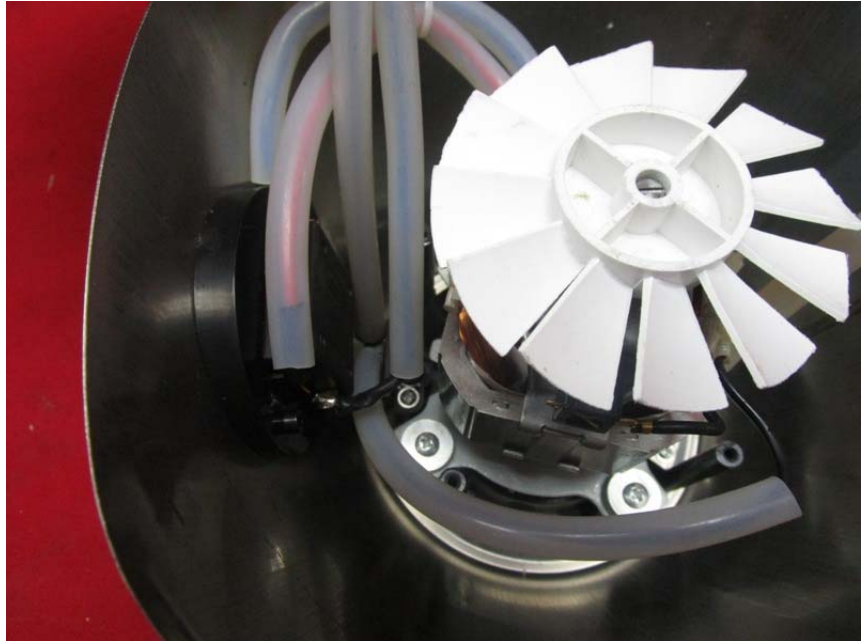

Details of: Inside view of model: BT-B12A, BT-B12B

View:

- general
- front
- rear
- right
- left
- top
- bottom



Attachment 5

Details of: Outside view of model: BT-B22A, BT-B22B

View:

- general
- front
- rear
- right
- left
- top
- bottom



Details of: Outside view of model: BT-B22A, BT-B22B

View:

- general
- front
- rear
- right
- left
- top
- bottom



Attachment 5

Details of: Outside view of model: BT-B22A, BT-B22B

View:

- general
- front
- rear
- right
- left
- top
- bottom

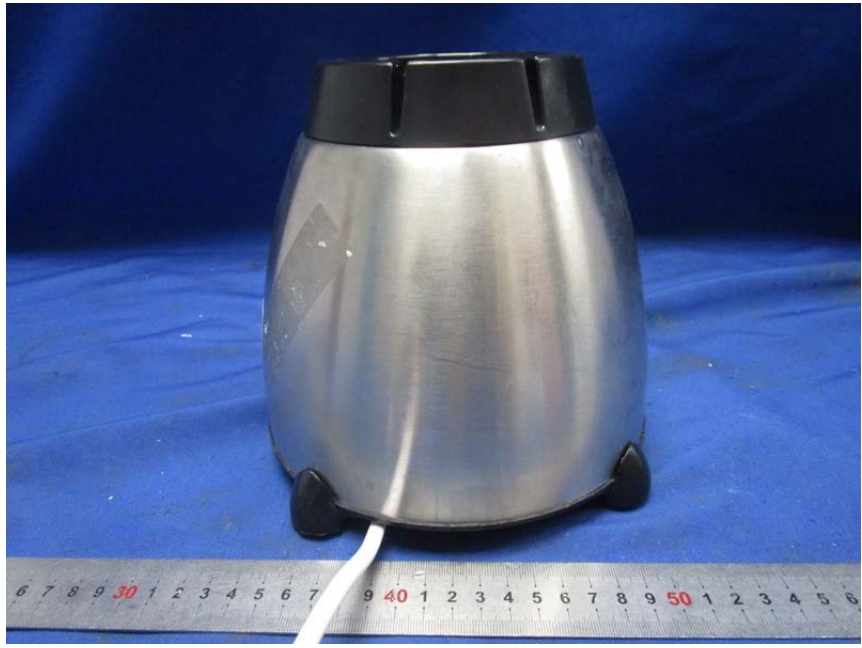

Details of: Outside view of model: BT-B22A, BT-B22B

View:

- general
- front
- rear
- right
- left
- top
- bottom

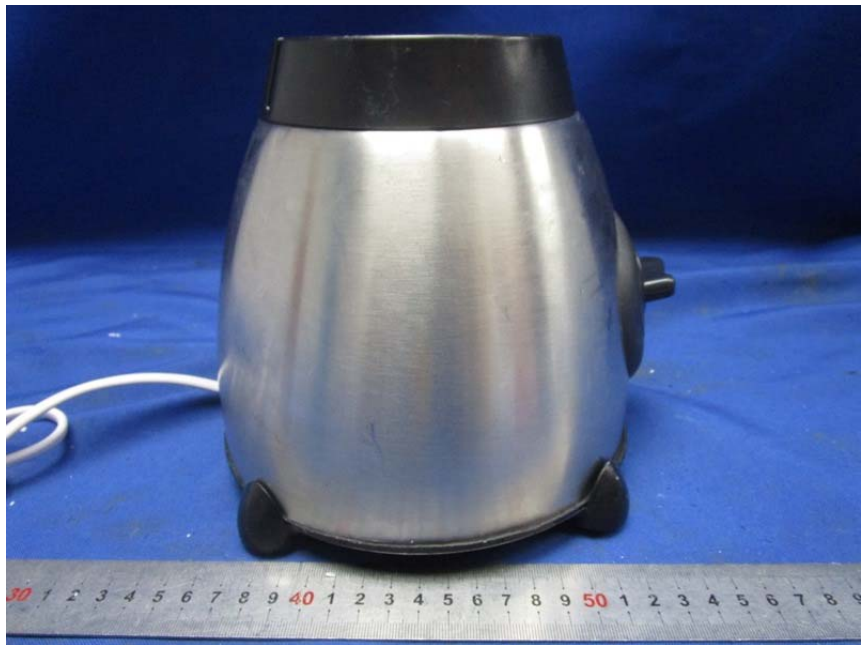

Attachment 5

Details of: Outside view of model: BT-B22A, BT-B22B

View:

- general
- front
- rear
- right
- left
- top
- bottom



Details of: Outside view of model: BT-B22A, BT-B22B

View:

- general
- front
- rear
- right
- left
- top
- bottom



Attachment 5

Details of: Outside view of model: BT-B22A, BT-B22B

View:

- general
- front
- rear
- right
- left
- top
- bottom



Details of: Inside view of model: BT-B22A, BT-B22B

View:

- general
- front
- rear
- right
- left
- top
- bottom

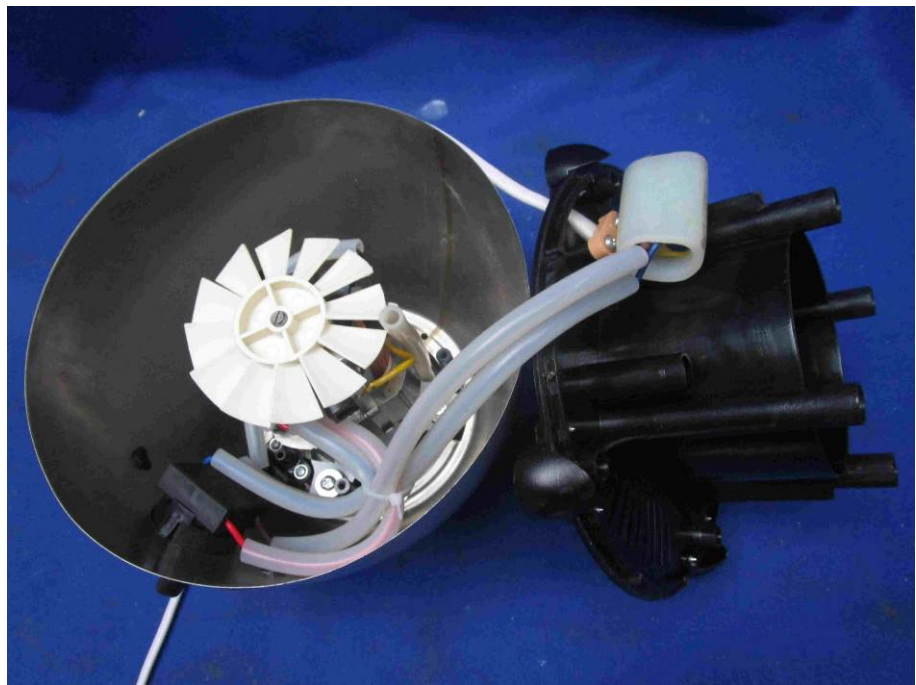

Attachment 5

Details of: Inside view of model: BT-B22A, BT-B22B

View:

- general
- front
- rear
- right
- left
- top
- bottom



Details of: Inside view of model: BT-B22A, BT-B22B

View:

- general
- front
- rear
- right
- left
- top
- bottom

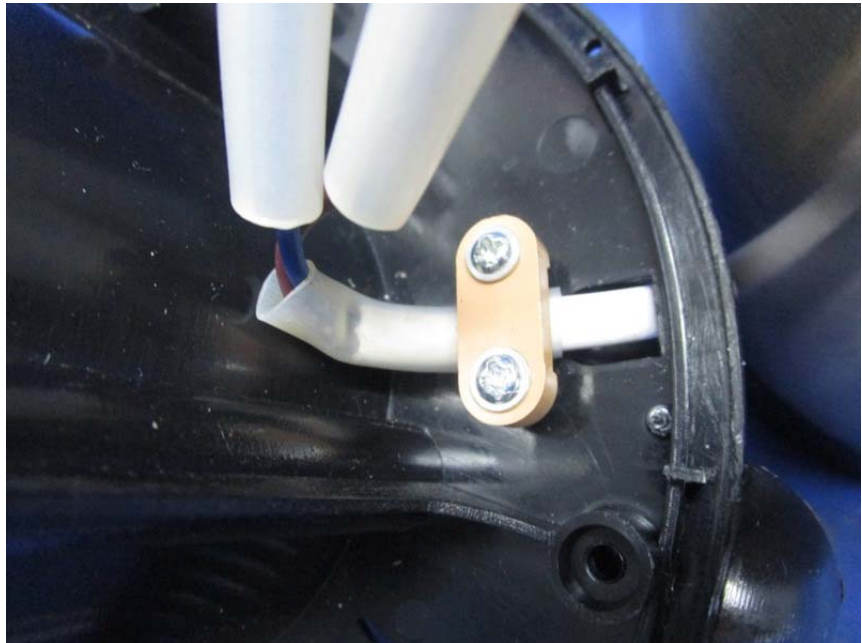

Attachment 5

Details of: Inside view of model: BT-B22A, BT-B22B

View:

- general
- front
- rear
- right
- left
- top
- bottom

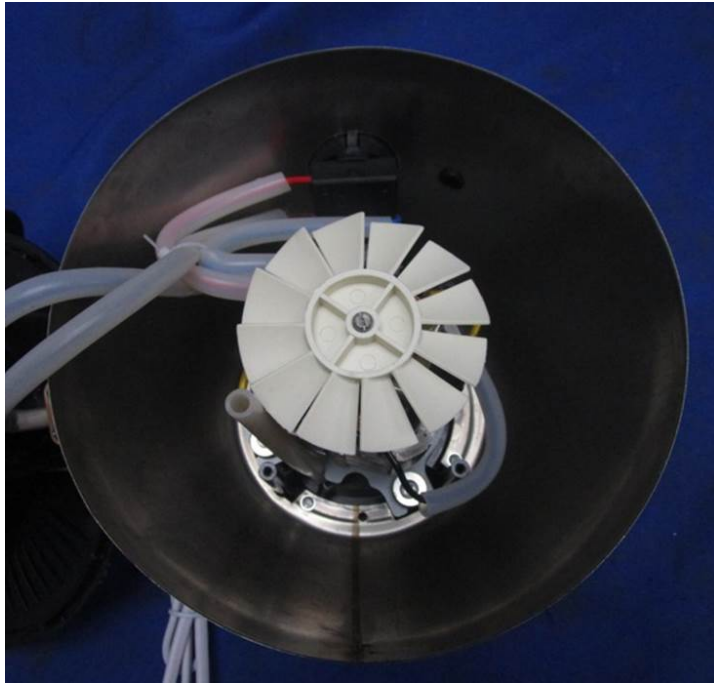

Details of: Inside view of model: BT-B22A, BT-B22B

View:

- general
- front
- rear
- right
- left
- top
- bottom

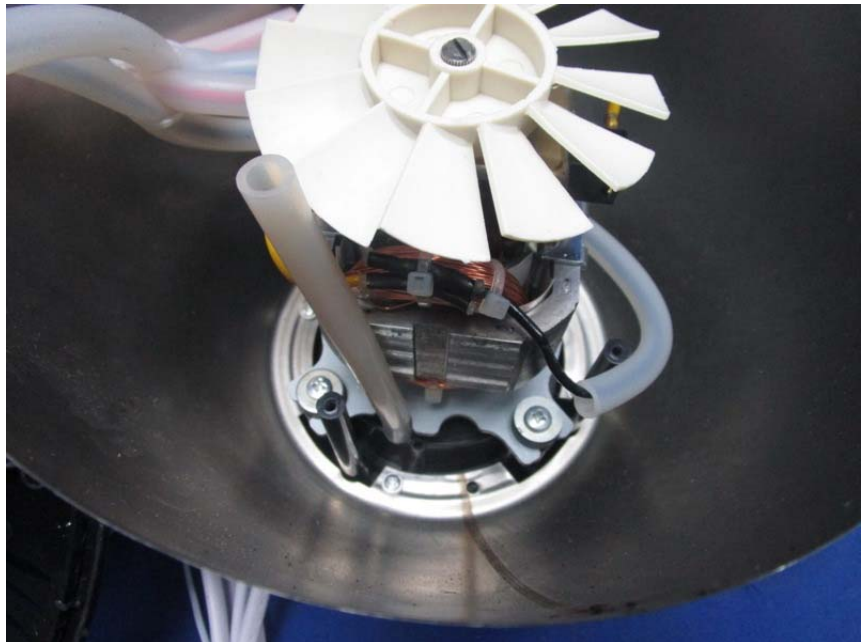

Attachment 5

Details of: Inside view of model: BT-B22A, BT-B22B

View:

- general
- front
- rear
- right
- left
- top
- bottom

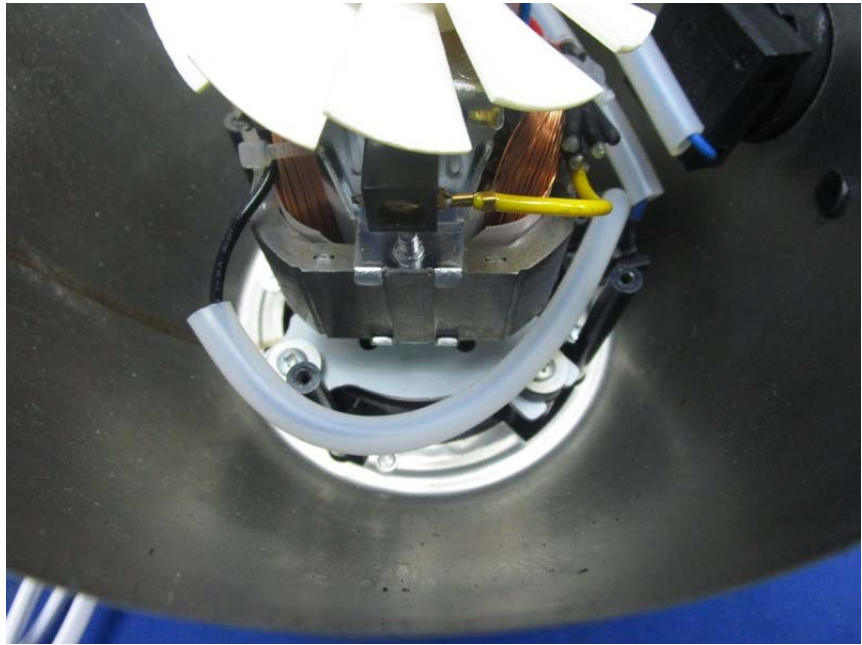

Details of: Inside view of model: BT-B22A, BT-B22B

View:

- general
- front
- rear
- right
- left
- top
- bottom

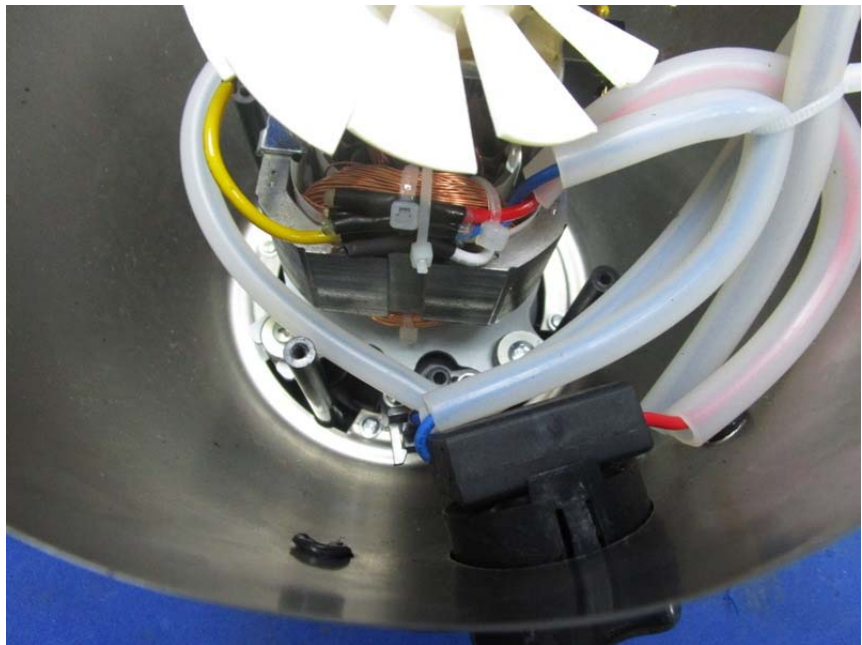

Attachment 5

Details of: Inside view of model: BT-B22A, BT-B22B

View:

- general
- front
- rear
- right
- left
- top
- bottom

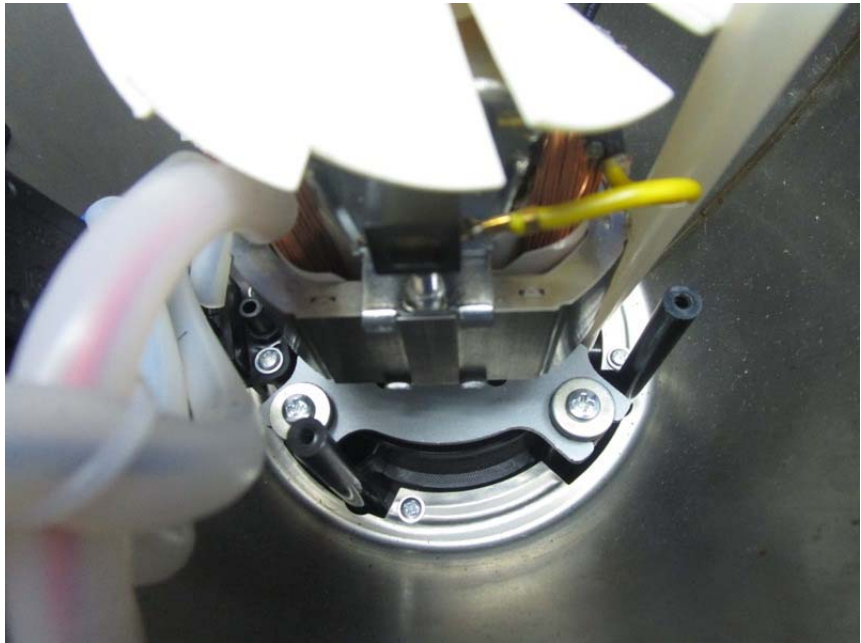

Details of: Inside view of model: BT-B22A, BT-B22B

View:

- general
- front
- rear
- right
- left
- top
- bottom

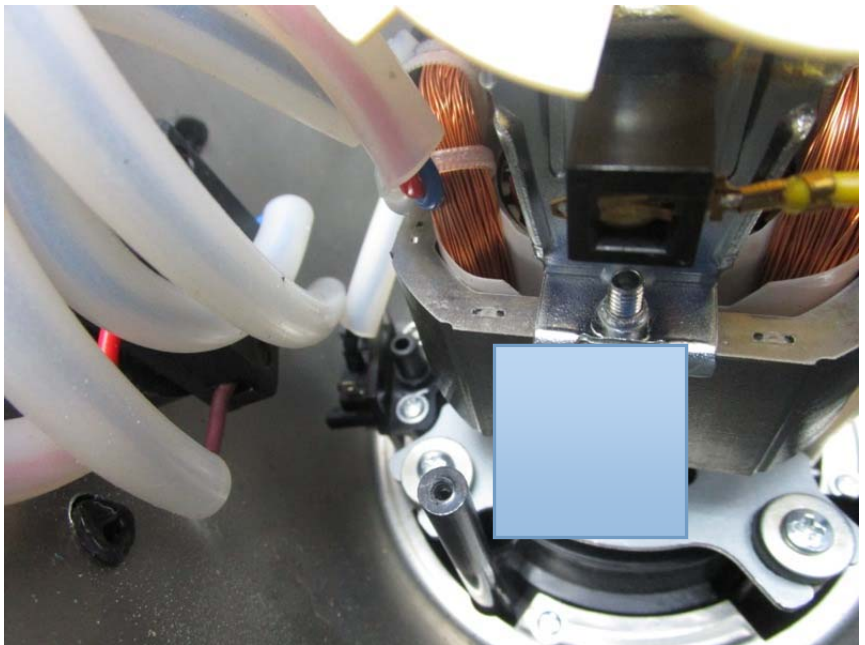

Attachment 5

Details of: Outside view of model: BT-B35A, BT-B35B

View:

- general
- front
- rear
- right
- left
- top
- bottom

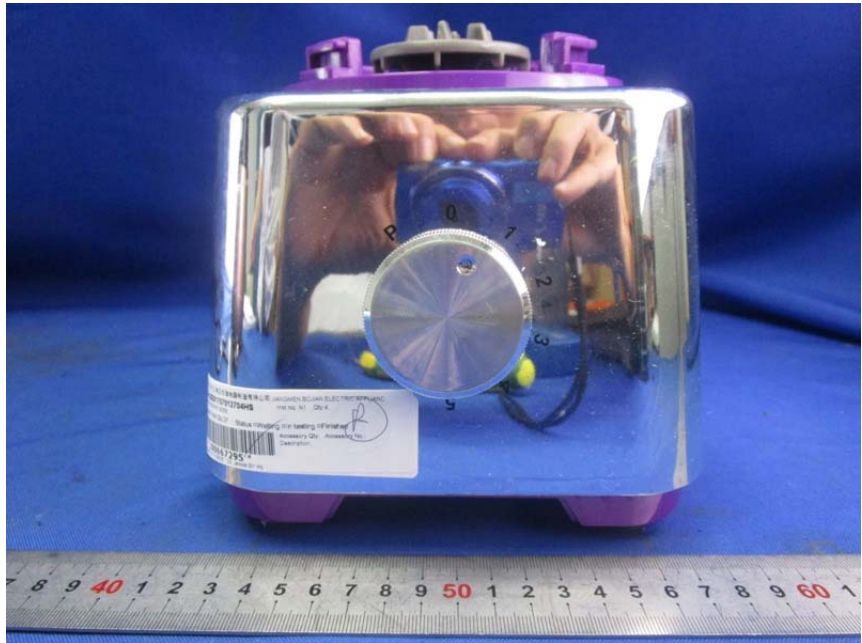

Details of: Outside view of model: BT-B35A, BT-B35B

View:

- general
- front
- rear
- right
- left
- top
- bottom

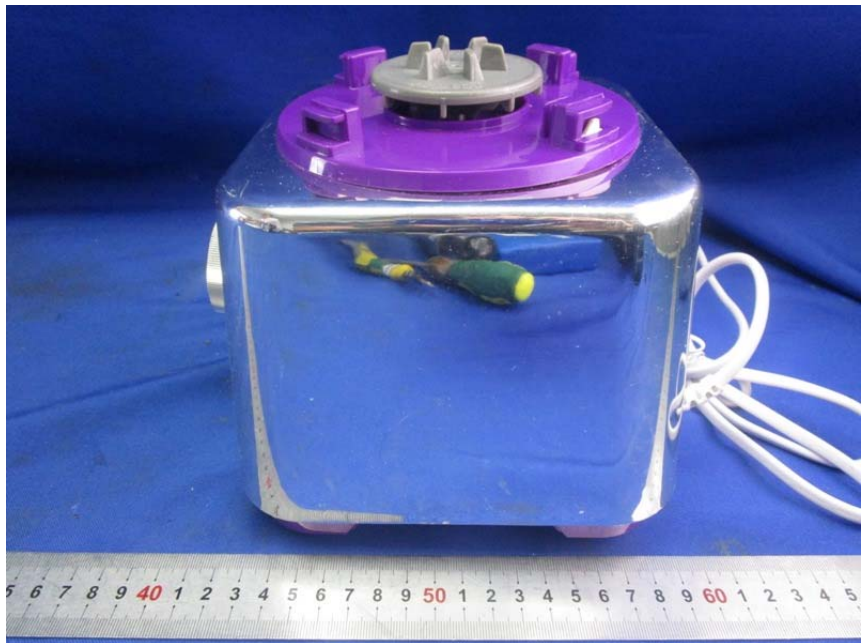

Attachment 5

Details of: Outside view of model: BT-B35A, BT-B35B

View:

- general
- front
- rear
- right
- left
- top
- bottom

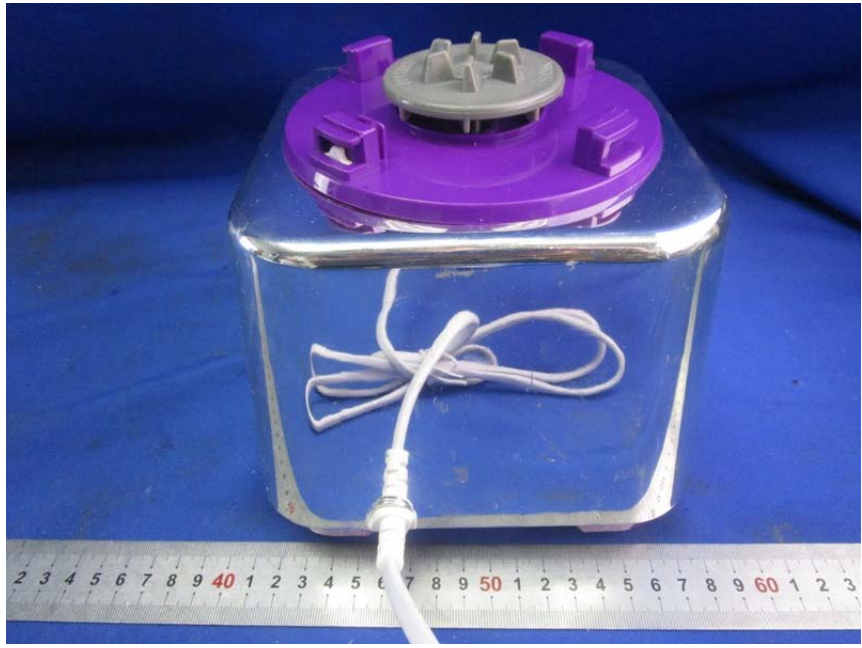

Details of: Outside view of model: BT-B35A, BT-B35B

View:

- general
- front
- rear
- right
- left
- top
- bottom



Attachment 5

Details of: Outside view of model: BT-B35A, BT-B35B

View:

- general
- front
- rear
- right
- left
- top
- bottom

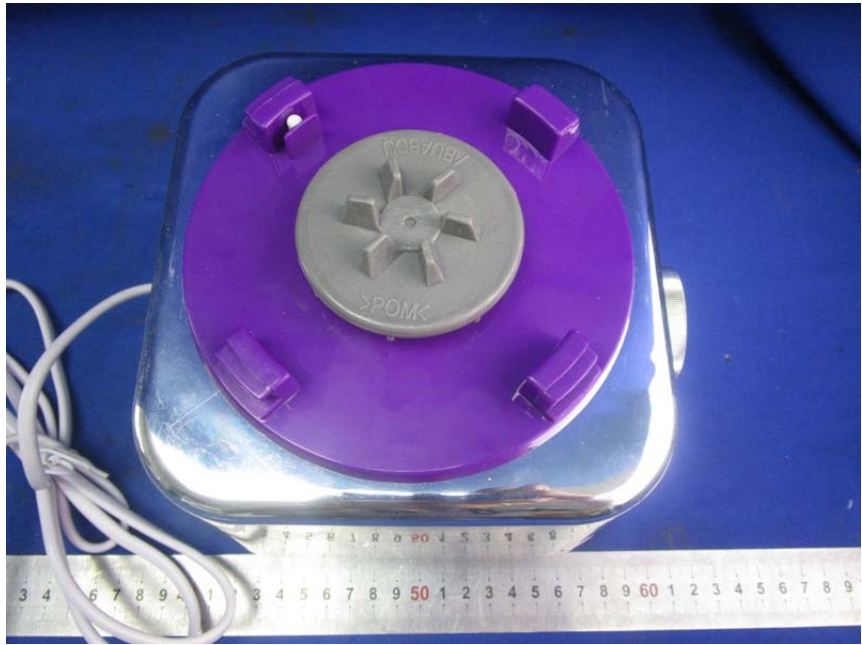

Details of: Outside view of model: BT-B35A, BT-B35B

View:

- general
- front
- rear
- right
- left
- top
- bottom

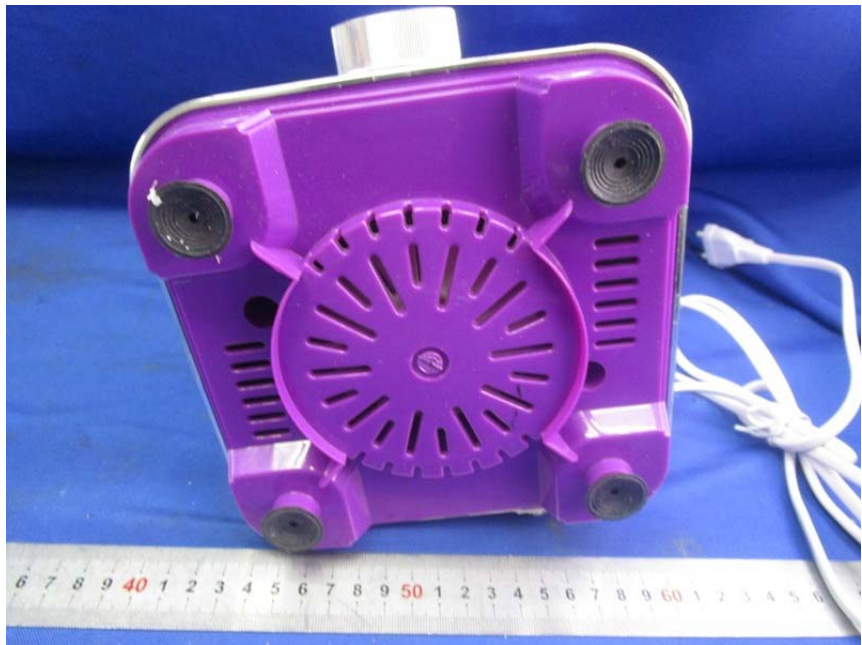

Attachment 5

Details of: Inside view of model: BT-B35A, BT-B35B

View:

- general
- front
- rear
- right
- left
- top
- bottom



Details of: Inside view of model: BT-B35A, BT-B35B

View:

- general
- front
- rear
- right
- left
- top
- bottom



Attachment 5

Details of: Inside view of model: BT-B35A, BT-B35B

View:

- general
- front
- rear
- right
- left
- top
- bottom

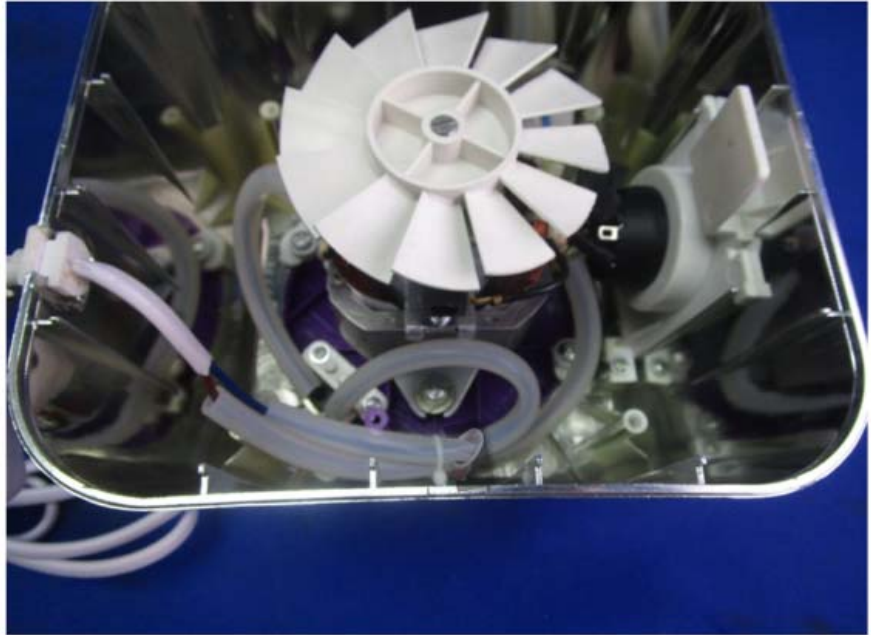

Details of: Inside view of model: BT-B35A, BT-B35B

View:

- general
- front
- rear
- right
- left
- top
- bottom

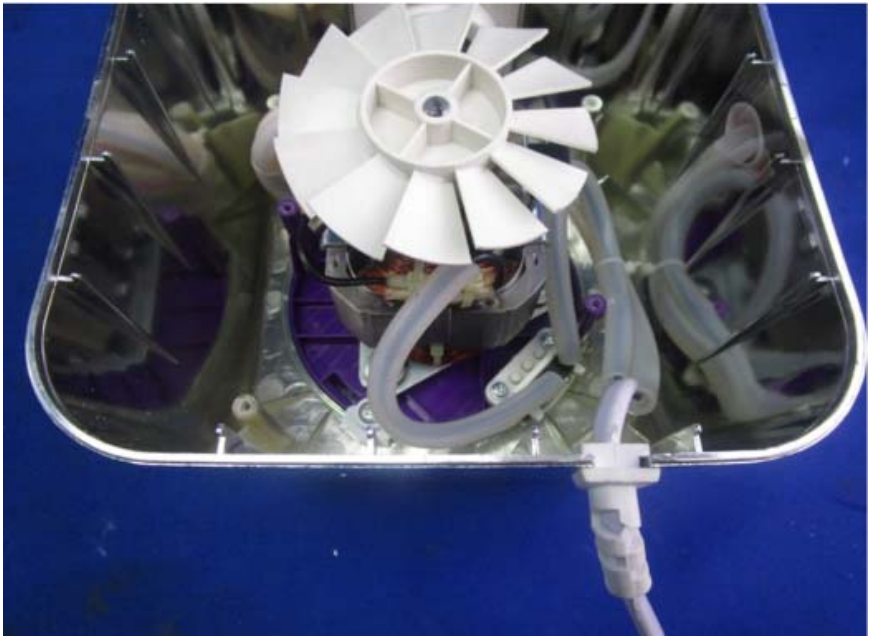

Attachment 5

Details of: Inside view of model: BT-B35A, BT-B35B

View:

- general
- front
- rear
- right
- left
- top
- bottom

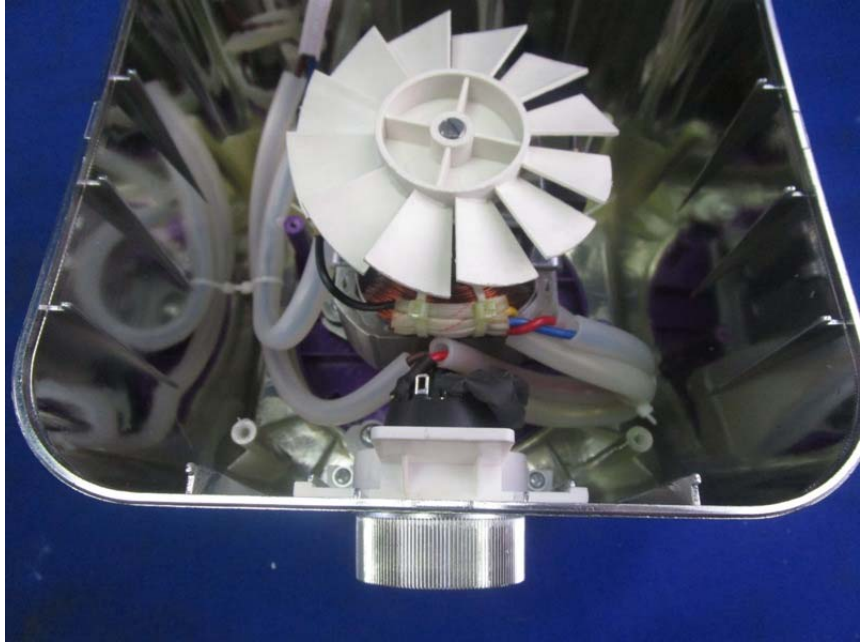

Attachment 5

Details of: Inside view of model: BT-B35A, BT-B35B

View:

- general
- front
- rear
- right
- left
- top
- bottom



Details of: Blender cup (Plastic, round) view of model: BT-B02B, BT-B05B, BT-B12B, BT-B15B, BT-B22B, BT-B25B

View:

- general
- front
- rear
- right
- left
- top
- bottom



Attachment 5

Details of: Blender cup (Plastic, round) view of model: BT-B02B, BT-B05B, BT-B12B, BT-B15B, BT-B22B, BT-B25B

View:

- general
- front
- rear
- right
- left
- top
- bottom



Details of: Blender cup (Plastic, round) view of model: BT-B02B, BT-B05B, BT-B12B, BT-B15B, BT-B22B, BT-B25B

View:

- general
- front
- rear
- right
- left
- top
- bottom

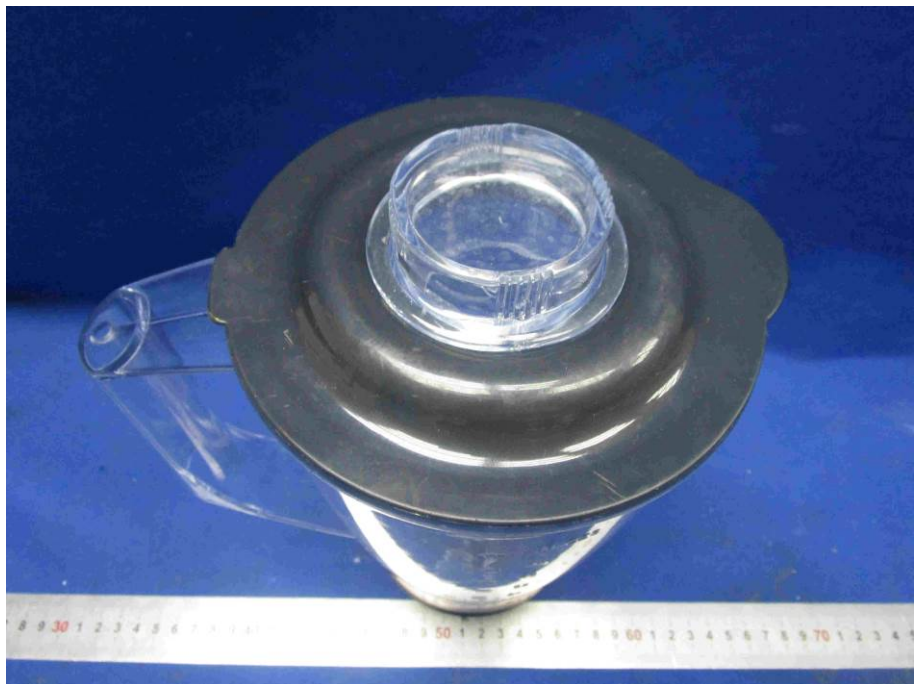

Attachment 5

Details of: **Blender cup (Plastic, round) view of model: BT-B02B, BT-B05B, BT-B12B, BT-B15B, BT-B22B, BT-B25B**

View:

- general
- front
- rear
- right
- left
- top
- bottom

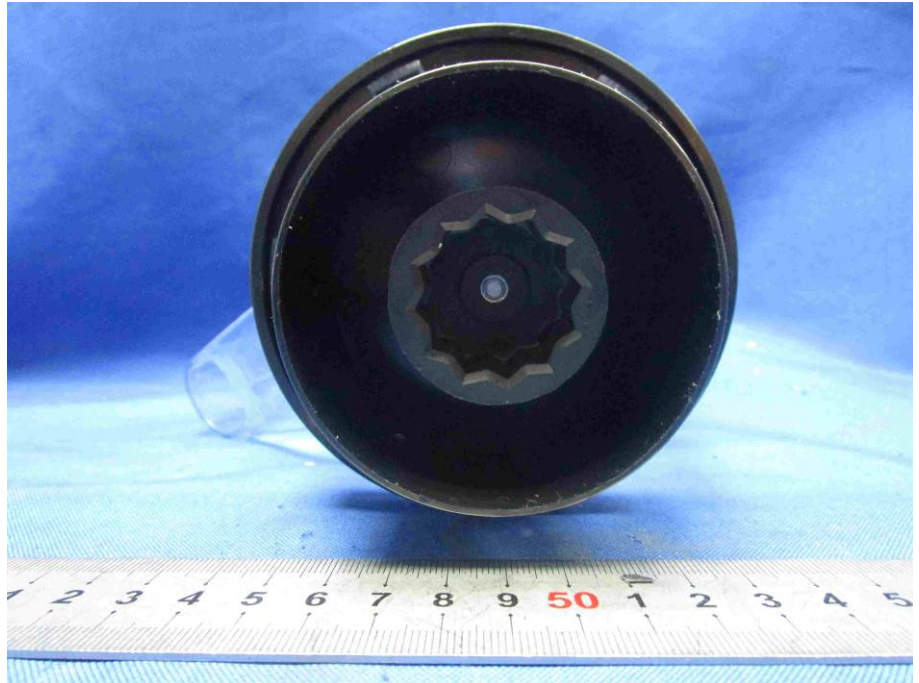

Details of: **Blender cup (glass, round) view of model: BT-B02A, BT-B05A, BT-B12A, BT-B15A, BT-B22A, BT-B25A**

View:

- general
- front
- rear
- right
- left
- top
- bottom



Attachment 5

Details of: Blender cup (glass, round) view of model: BT-B02A, BT-B05A, BT-B12A, BT-B15A, BT-B22A, BT-B25A

View:

- general
- front
- rear
- right
- left
- top
- bottom



Details of: Blender cup (glass, round) view of model: BT-B02A, BT-B05A, BT-B12A, BT-B15A, BT-B22A, BT-B25A

View:

- general
- front
- rear
- right
- left
- top
- bottom

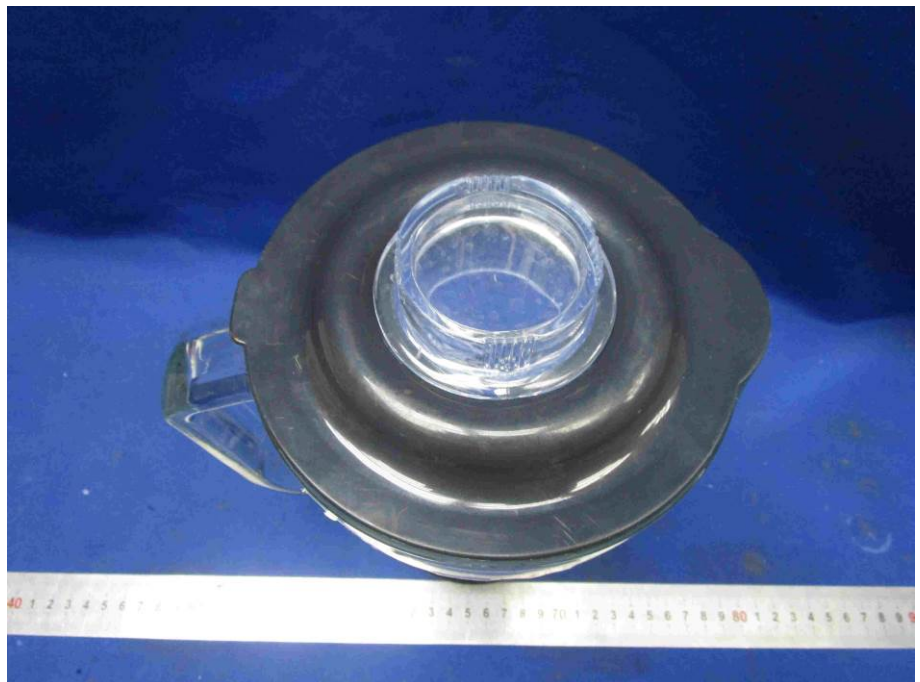

Attachment 5

Details of: **Blender cup (glass, round) view of model: BT-B02A, BT-B05A, BT-B12A, BT-B15A, BT-B22A, BT-B25A**

View:

- general
- front
- rear
- right
- left
- top
- bottom

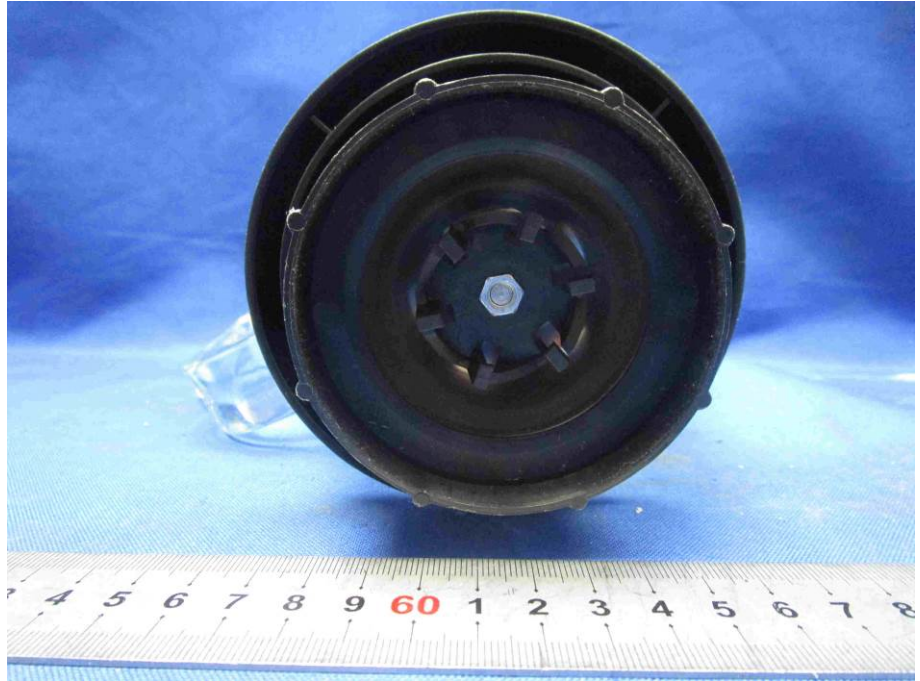

Details of: **Blender cup (glass, triangle) view of model: BT-B32A, BT-B35A**

View:

- general
- front
- rear
- right
- left
- top
- bottom



Attachment 5

Details of: Blender cup (glass, triangle) view of model: BT-B32A, BT-B35A

View:

- general
- front
- rear
- right
- left
- top
- bottom



Details of: Blender cup (glass, triangle) view of model: BT-B32A, BT-B35A

View:

- general
- front
- rear
- right
- left
- top
- bottom



Attachment 5

Details of: Blender cup (glass, triangle) view of model: BT-B32A, BT-B35A

View:

- general
- front
- rear
- right
- left
- top
- bottom



Details of: Blender cup (Plastic, triangle) view of model: BT-B32B, BT-B35B

View:

- general
- front
- rear
- right
- left
- top
- bottom



Attachment 5

Details of: Blender cup (Plastic, triangle) view of model: BT-B32B, BT-B35B

View:

- general
- front
- rear
- right
- left
- top
- bottom



Details of: Blender cup (Plastic, triangle) view of model: BT-B32B, BT-B35B

View:

- general
- front
- rear
- right
- left
- top
- bottom

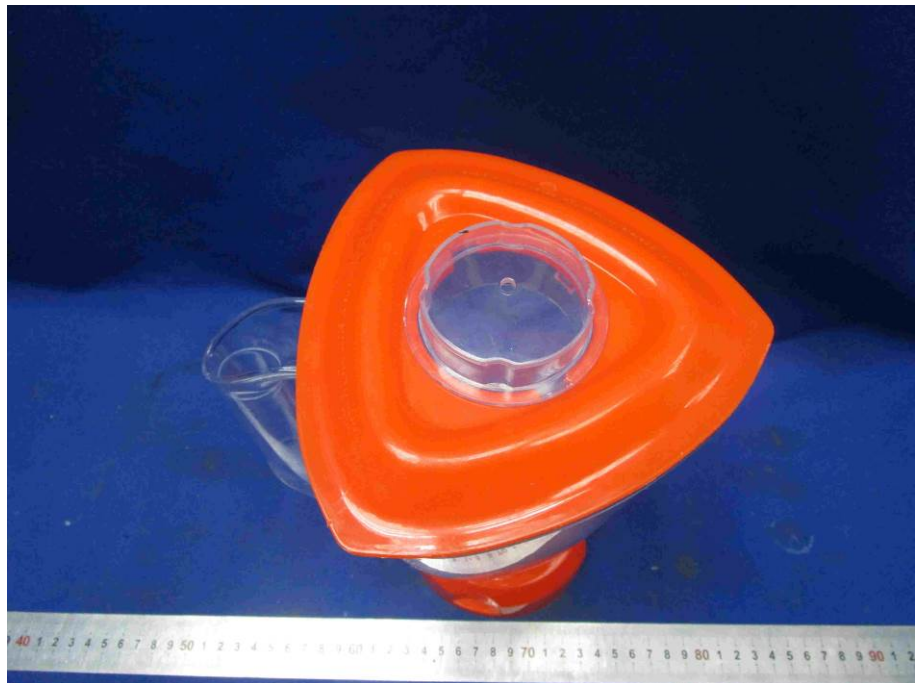

Attachment 5

Details of: Blender cup (Plastic, triangle) view of model: BT-B32B, BT-B35B

View:

- general
- front
- rear
- right
- left
- top
- bottom

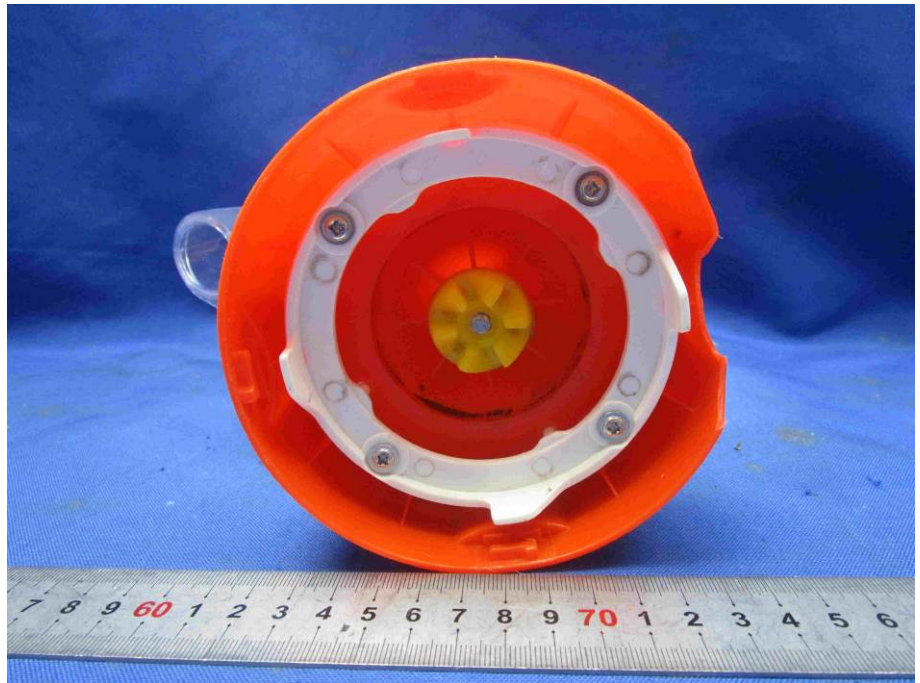

Details of: Coffee mill cup view of model: BT-B02A, BT-B02B, BT-B05A, BT-B05B, BT-B12A, BT-B12B, BT-B15A, BT-B15B, BT-B22A, BT-B22B, BT-B25A, BT-B25B

View:

- general
- front
- rear
- right
- left
- top
- bottom

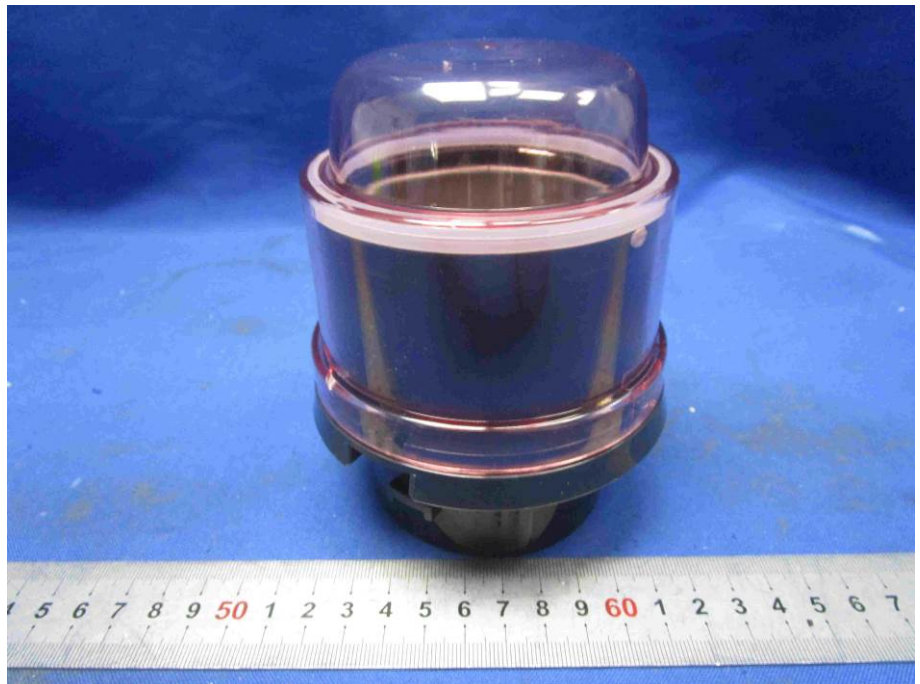

Attachment 5

Details of:

Coffee mill cup view of model: BT-B02A, BT-B02B, BT-B05A, BT-B05B, BT-B12A, BT-B12B, BT-B15A, BT-B15B, BT-B22A, BT-B22B, BT-B25A, BT-B25B

View:

- general
- front
- rear
- right
- left
- top
- bottom



Details of:

Coffee mill cup view of model: BT-B02A, BT-B02B, BT-B05A, BT-B05B, BT-B12A, BT-B12B, BT-B15A, BT-B15B, BT-B22A, BT-B22B, BT-B25A, BT-B25B

View:

- general
- front
- rear
- right
- left
- top
- bottom

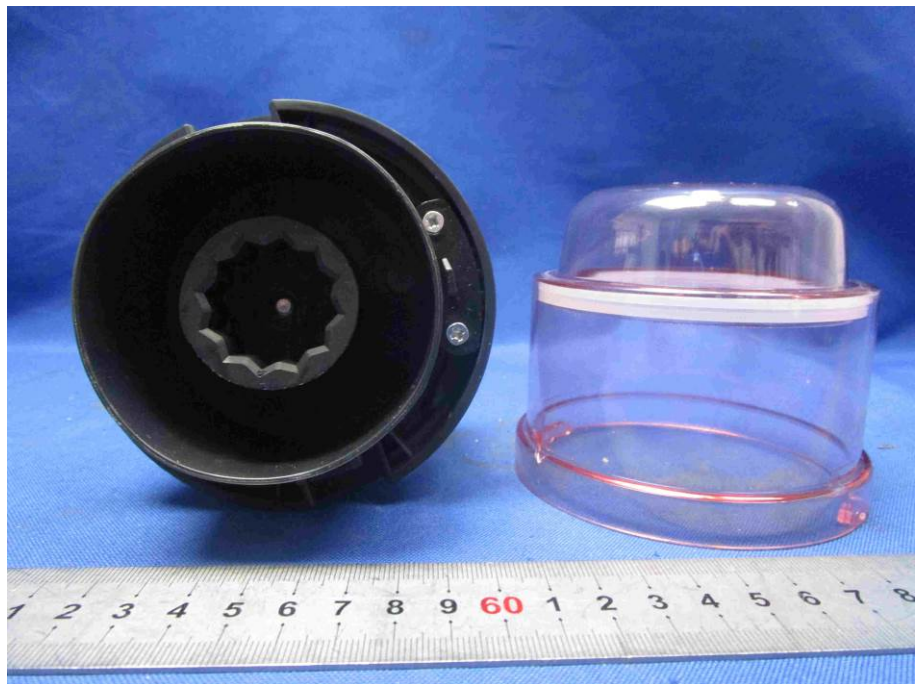

Attachment 5

Details of: Coffee mill cup view of model: BT-B32A, BT-B32B, BT-B35A, BT-B35B

View:

- general
- front
- rear
- right
- left
- top
- bottom

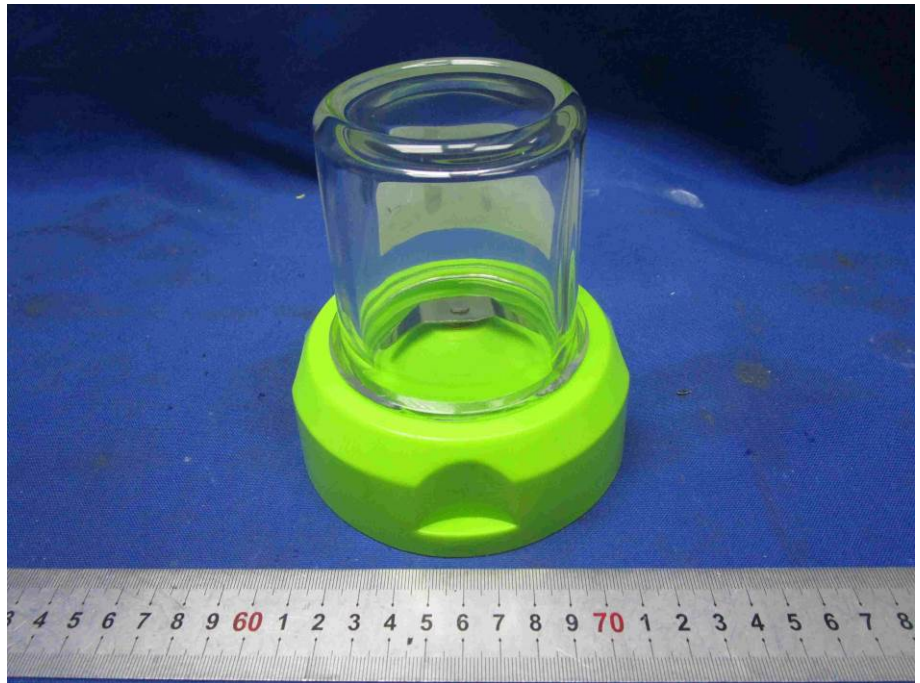

Details of: Coffee mill cup view of model: BT-B32A, BT-B32B, BT-B35A, BT-B35B

View:

- general
- front
- rear
- right
- left
- top
- bottom

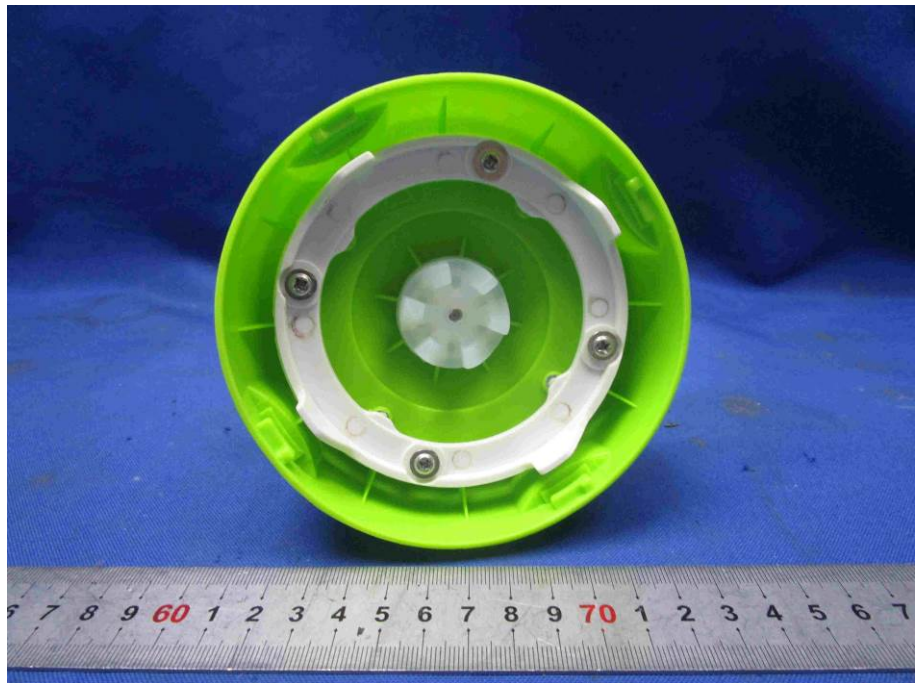

Attachment 5

Details of: PCB view of all models

View:

- general
- front
- rear
- right
- left
- top
- bottom

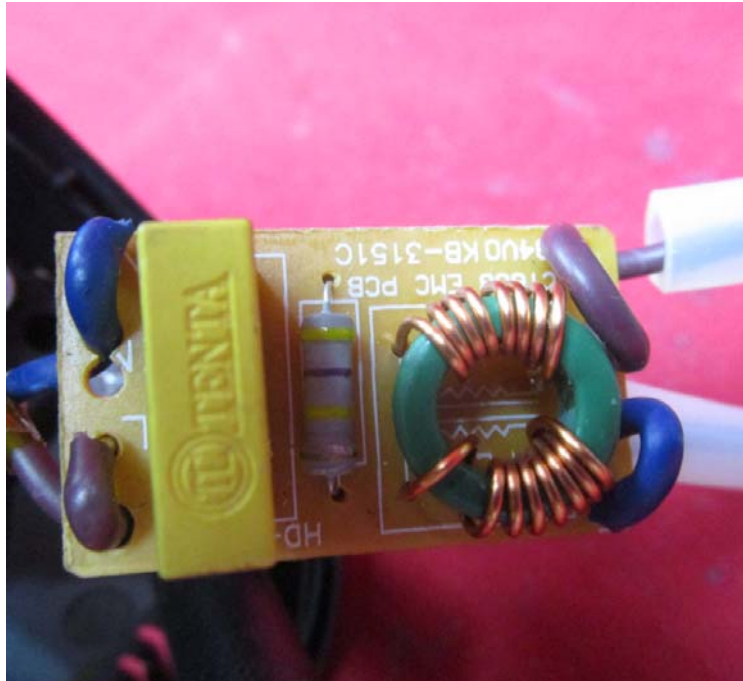

Details of: PCB view of all models

View:

- general
- front
- rear
- right
- left
- top
- bottom

