

**BAGUELESS VACUUM CLEANER**  
**CLASS A**  
**INSTRUCTION MANUAL**



**TAS-7001A**



**TAS-7006A**

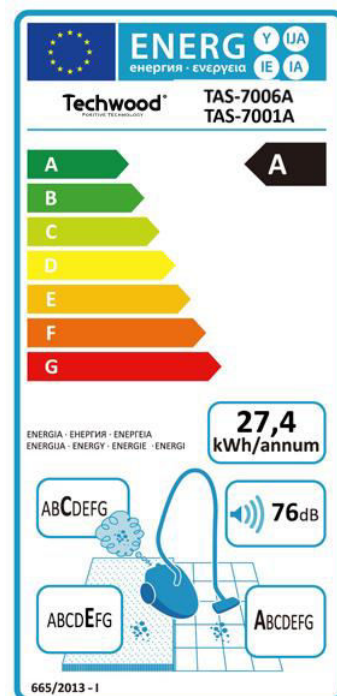

Dear consumer, Please read these instructions carefully before use in order to avoid damage due to incorrect use and to better understand the functions of this product. Please pay particular attention to the safety guide.

If you pass the device on to a third party, these Operating Instructions must also be handed over.

Please keep them for future references.

## IMPORTANT SAFEGUARDS

- ❑ Please read these instructions carefully before use.
- ❑ Keep present instructions for future references.
- ❑ Check that your mains voltage corresponds to that stated on the appliance.
- ❑ Only use the appliance for domestic purposes and household or similar applications such as:
  - Staff kitchen areas, in shops, offices and other working environments;
  - Farm houses;
  - By clients in hotels, motels and other residential type environments;
  - Bed and breakfast type environments
- ❑ Only use the appliance in the way indicated in these instructions.
- ❑ Never use this unit near bathtub, shower, wash-hand basins or other containers with water.
- ❑ Never use this apparatus near water projections.
- ❑ Never use this apparatus with the wet hands.
- ❑ If, unfortunately the apparatus is wet, immediately withdraw the cord of the socket-outlet.
- ❑ Inform potential users of these instructions.
- ❑ Never leave the appliance unsupervised when in use.
- ❑ The appliance must be used only for its intended purpose. No responsibility can be taken for any possible damage caused by incorrect use or improper handling.
- ❑ Children and persons with disabilities are not always aware of the danger posed by the use of appliances.
- ❑ This device can be used by children aged 8 years and older and adults, with reduced physical, sensory or mental capabilities or lack of experience and knowledge, if they have been given supervision or instruction concerning use of the appliance in a safe way and understand the hazards involved.
- ❑ This appliance can be used by children aged from 8 years and above and persons with reduced physical, sensory or mental capabilities or lack of experience and knowledge if they have been given supervision or instruction concerning use of the appliance in a safe way and understand the hazards involved.
- ❑ Children shall not play with the appliance.
- ❑ Cleaning and user maintenance shall not be made by children without supervision.
- ❑ In order to ensure your children's safety, please keep all packaging (plastic bags, boxes, polystyrene etc.) out of their reach.
- ❑ Caution ! Do not allow small children to play with the foil :  
**THERE IS A DANGER OF SUFFOCATION !**
- ❑ From time to time check the cord for damages. Never use the appliance if cord or appliance shows any signs of damage.
- ❑ Never immerse the appliance in water or any other liquid for any reason whatsoever.

- ❑ Never place it into the dishwasher.
- ❑ Never use the appliance near hot surfaces.
- ❑ Do not operate the appliance with a damaged cord or plug, or after the appliance has been damaged in any manner.
- ❑ If the supply cord or appliance is damaged, it must be replaced by the manufacturer or its service agent or a similarly qualified person in order to avoid a hazard.
- ❑ Disconnect the power source cable before any operation of cleaning of maintenance and accessories assembly.
- ❑ Never use the appliance outside and always place it in a dry environment.
- ❑ Never use accessories, which are not recommended by the producer. They could constitute a danger to the user and risk to damage the appliance.
- ❑ Never use any other connector than the one provided.
- ❑ Never move the appliance by pulling the cord. Make sure the cord cannot get caught in any way.
- ❑ Never wind the cord around the appliance and do not bend it
- ❑ Ensure that the power cord does not come into contact with hot parts of this unit.
- ❑ Make sure the appliance has cooled down before cleaning and storing it.
- ❑ The temperature of accessible surfaces may be very high when the appliance is operating. Never touch these parts, of apparatus, to avoid burning itself.
- ❑ Make sure the appliance never comes into contact with flammable materials, such as curtains, cloth, etc...& the power cord and plug do not come in contact with water.
- ❑ Before cleaning, always unplug the appliance from the power supply and let it cool down.
- ❑ This appliance is not intended to be operated by means of an external timer or separate remote-control system.
- ❑ Always place the unit on a flat surface. Ensure, also, not to cover the device and not to put anything on it.
- ❑ Always remove the plug from the wall socket when the appliance is not in use.
- ❑ When using an extension lead always make sure that the entire cable is unwound from the reel. Use solely CE approved extension leads. Input power must be at least 16A, 250V, 3000W.
- ❑ Incorrect operation and improper use can damage the appliance and cause injury to the user.
- ❑ This device, designed for home use, complies with standards relating to this type of product.
- ❑ The appliance must be used and rested on a table or flat & stable surface.
- ❑ The item must not be left unattended when it is connected to main supply.
- ❑ The item is not to be used, if it has been dropped or if there are visible signs of damage or if it is leaking.
- ❑ This appliance is only intended for household use.

## FIRST USE

Before first use, remove the unit and all accessories carefully and paying attention to the sharp accessories.

Clean with soap and water, bowls and all accessories. Rinse and dry thoroughly. Clean the outside and inside of the machine cabinet with a damp cloth and wipe dry.

## USE

- Unroll the power cord completely.
- Check that the tension in force in the country where you are corresponds to that indicated on the apparatus.
- Connect the apparatus in a correct socket-outlet, (and connected to the ground if the unit is Class I), to avoid any danger.
- Disconnect the power source cable before any operation of cleaning of maintenance and accessories assembly.
- Never modify the appliance in anyway.

## NAME OF MAIN PARTS

### DESCRIPTION

- A. Handle
- B. Hose
- C. Wind force adjuster
- D. Tube
- E. Floor brush
- F. Hose connector
- G. Dustbin
- H. Cord rewind button
- I. Power switch

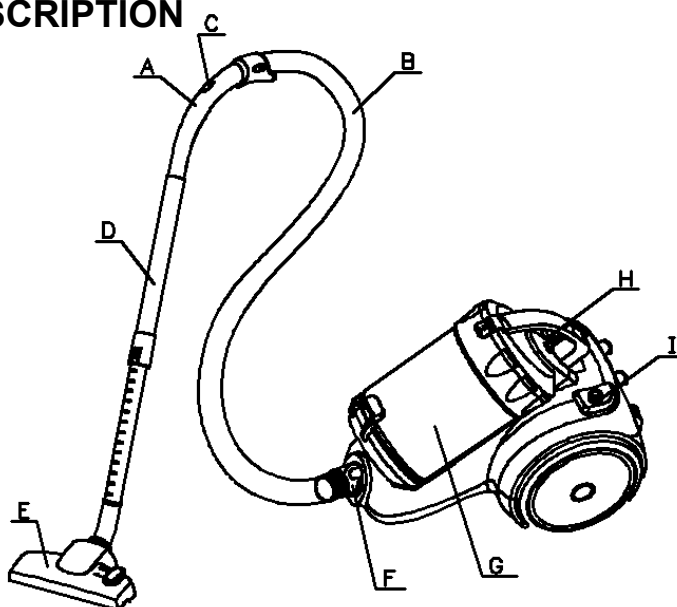

## IMPORTANT

- . Read this instruction booklet carefully.
- . Before using the appliance, check that the mains power voltage corresponds to the voltage shown on the rating plate.
- . The appliance should be connected to a correctly-earthed 10 power socket.
- . Always remove the plug from the power socket when the appliance is not in use and before carrying out any cleaning or maintenance operations.

- . Always remove the plug from the power sock before opening the appliance.
- . Never use methylated spirits or other solvents to clean the appliance.
- . Do not use the appliance to vacuum liquids.
- . Never leave the appliance unattended when it is switched on. Keep the appliance out of the reach of children or the infirm.
- . This appliance is for domestic use only. Use as described in this instruction booklet.
- . Do not switch the appliance on if it appears to be faulty in any way.
- . For repairs or accessories. Contact your dealer or an authorized Service Centre.
- . If the supply cord is damaged, the manufacturer or its service agent or a similarly qualified person must replace it in order to avoid a hazard.

Do not remove the plug from by pulling the cable the or appliance itself	Do not use the appliance to over the power cable	Do not use the appliance to vacuum lighted matches, cigarettes end or hot ash.
--	--	--

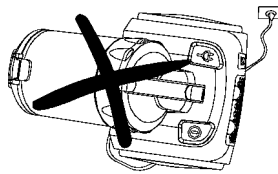
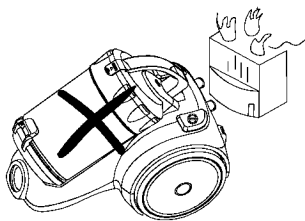

Do not use the appliance on the wet surfaces.	Do not obstruct the air intake or outlet vent.	Do not use the appliance to vacuum needles, drawing –pins or string.
---	--	--

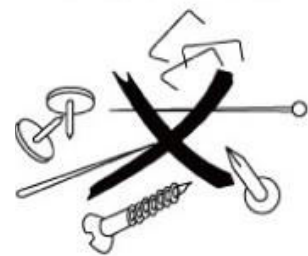
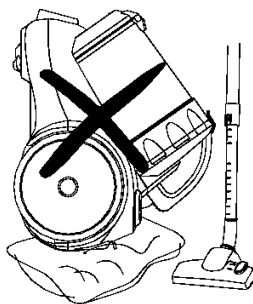

## ASSEMBLING THE VACUUM CLEANER

### Removing the flexible tube

Remove the plug from the power socket. To release the flexible tube, press the button on the end of the tube and pull the tube firmly from the air intake duct.

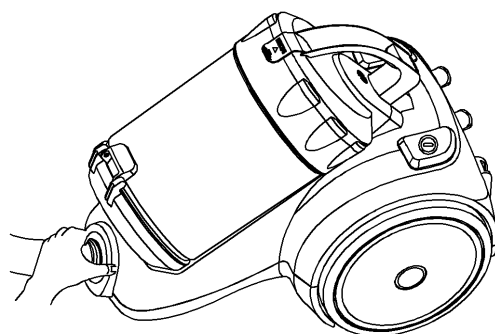

## Fitting the extension tubes and accessories

Fitting the extension tube to the handle	Fitting the extension tube	Fitting the accessories to the extension tube
--	----------------------------	---

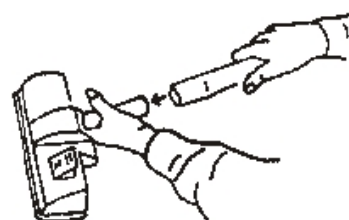
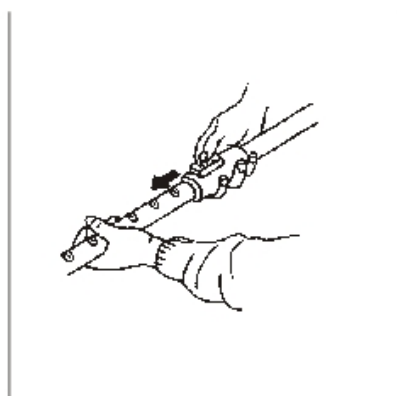
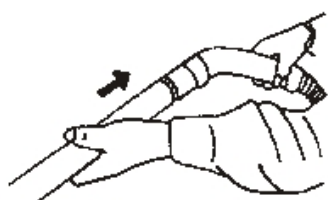

## INSTRUCTION FOR USE

1. Before using the appliance, unwind length of cable and insert the plug into the power socket. Do not extend the cable beyond the RED mark. To rewind the power cable, press the rewind button with one hand, and guide the other hand to ensure that it does not whip causing damage
2. Press the ON/OFF button to switch the appliance on.

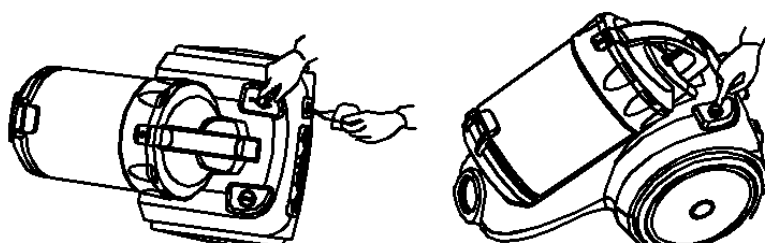
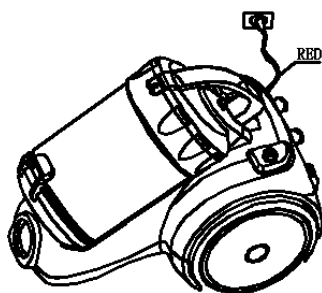

## USING THE CLEANING ACCESSORIES

- **Dual-position carpet/floor brush.**

Pos. 1: bristles extended. for hard floors	Pos. 2: bristles retracted for carpets
--	--

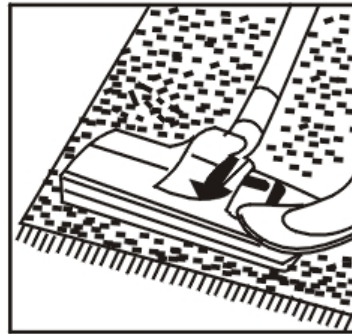

<p><b>Narrow nozzle.</b> For cleaning radiators: corners, edges, drawers etc.</p>	<p><b>Small brush</b> For cleaning curtains, shelves, books, inlaid furniture, lamps and other delicate objects.</p>
---	--



### Clean the dust

- 1, Lift the form cover and take out the dust cup.
- 2, Take out the foam form dust cup.
3. clean off the dust inside the dust cup.

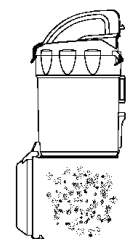
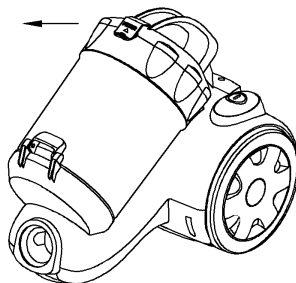

## Clean the foam

1. Take out the foam when it's setting dirties.
2. Clean it in the water, dry it naturally before next use.

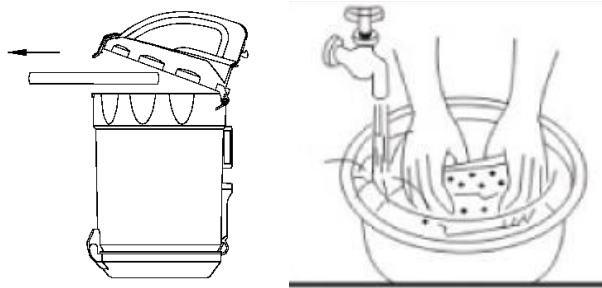

## CLEANING AND MAINTENANCE

Before cleaning, Always: switch off the appliance, disconnect the apparatus and let it cool.

Clean the outside of the apparatus with a sponge or slightly wet linen.

The parts (removable) in contact with food like plate, bowl, forks, Spatula etc. can be washed in hot water with sponge and soft detergent or put in the dishwasher.

Never plunge the apparatus in water or all other liquid !

Do not use abrasive cleaners, gritting, or metal brush or another cutting object.

## STORAGE

- Ensure the unit is completely cool and dry.
- Do not wrap the cord around the appliance, as this will cause damage.
- Keep the appliance in a cool, dry place and out of reach from children.

## GUARANTEE

Before being delivered, all our products are subjected to a rigorous control.

This apparatus is guaranteed 12 months starting from the date of purchase.

The documents in proof of guarantee are :

The invoice and

The filled and stamped warrantee plate (located on side or bottom of the gift box).

Without these documents in proof, no free replacement, nor no free repair, can be carried out.

During the warranty period, we deal for free, the defects of the apparatus or the accessories, rising from a defect of materials or manufacture by repair or, replacement. The services within the framework of the guarantee do not involve any extension of the warranty period and does not give right to a new guarantee! In the event of recourse to the guarantee, bring back the complete apparatus to your retailer, in its original packing, accompanied by the proofs of purchase.



The breakage of parts out of glass or plastic is, in all the cases, not warranted. Defects on the accessories or the wearing parts (for example: coals of engines, hooks, drive belts, remote control of replacement, teeth brushes of replacement, webs etc) as well as cleaning, maintenance or it replacement of wearing parts are not guaranteed and are thus to pay!

In the event of foreign intervention, the guarantee becomes null and void.

After flow of the warranty period, repairs can be carried out, against payment, by a specialized trade or a repair service.

## **SPECIFICATIONS**

Power supply	220-240V~ 50/60Hz
Input Power	700 W
Class	A
Annual Consumption	27,4 KWH/YEAR
Norm	Class II
Air flow	17,5 L/s
Pressure	22 Kpa
Noise	76 dB

*The characteristics can change without preliminary preventing*

Always unplug the appliance before any cleaning or maintenance operation and accessories assembly.

**CAUTION:** If the electric cable is damaged, it must be replaced by the manufacturer, his after-sales service or people with similar qualification, in order to avoid any danger. In order to minimize the risks of electric shock, In the event of breakdown, not to open the case but to call upon a qualified technician for repairs.

This apparatus satisfied EC directives, it was controlled according to all the European current directives, like: electromagnetic compatibility (EMC) and low tension (LVD). This apparatus was designed and manufactured in respect of the last safety regulations and technical specifications.

## GENERAL INFORMATION

The symbol "OPEN BOOK" means a recommendation to read important things contained in the record.



The symbol "FLASH" is intended to alert the user to the presence of current within the device. Do not open it, it could constitute a risk of electric shock.



The symbol "QUESTION MARK" warns the user that important operating and maintenance are contained in the record.



The symbol "TUB / SHOWER" crossed out means to never use the unit in a bathroom, a shower in or near water spray. (IP20 Minimum distance 3M.)



The symbol "BIN" crossed out, abbreviation WEEE (Waste of Electrical and Electronic Equipment) means that at the end of life, it should not be discarded with household waste, but filed to the sorting of the locality. Waste recovery can help preserve our environment.



The symbol "STEAM" warns the user that steam can escape from the unit and to take all necessary precautions. (Risk of burns)



The symbol "CE" is the guarantee of compliance with harmonized European standards, voluntary, reflecting the essential requirements into technical specifications. These standards are not mandatory but are guarantees of compliance with essential requirements.



The symbol "RECYCLING" raise consumer awareness on the need to recycle its waste. Recycling is a process by which materials that compose a product in end of life (industrial or household waste) are reused in whole or part and will be returned to the initial production cycle.



The symbol "GLASS / FORK" means that the device is compatible and can come into contact with foodstuffs.



The symbol ROHS (Restriction of use of some Hazardous Substances) on the Environmental Protection, certifies that for each of the five hazardous substances • Lead • Mercury • (hexavalent) chromium • products for protection against flames PBB and PBDE, the peak concentration is equal to or less than 0.1% of the weight of homogeneous material, and 0.01% for the 6th • cadmium.



The symbol "HOT WALL" warns the user that the walls of the unit can become very hot, and to take precautions as required.



The symbol "DOUBLE SQUARE" means a double insulated. A basic insulation and supplementary insulation. This device requires no connection to the mass of a protective conductor grounded. The materials are said : double insulation class II.

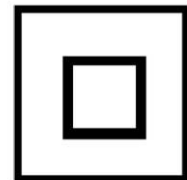

The symbol "MAN" means that the device can be used on the skin or human orifices. (Example: Thermometer).



The symbol "TRIMAN" indicates that the consumer is invited to dispose the product as part of a separate collection (eg recycling bin, waste, voluntary intake point).



For more information : [www.quefairedemesdechets.fr](http://www.quefairedemesdechets.fr)

**Imported by Sotech International  
" LE PERIPOLE " N°C111 à 115  
33, Avenue du Marechal de Lattre de Tassigny  
94120 Fontenay sous bois - France**