

**ELECTRIC MULTIFUNCTION COOKER
& PIZZA PAN**
Instruction manual



TP-3034 = 30cm

TP-3842 = 38cm



Dear consumer, Please read these instructions carefully before use in order to avoid damage due to incorrect use and to better understand the functions of this product. Please pay particular attention to the safety guide.

If you pass the device on to a third party, these Operating Instructions must also be handed over.

Please keep them for future references.

IMPORTANT SAFEGUARDS

- Please read these instructions carefully before use.
- Keep present instructions for future references.
- Check that your mains voltage corresponds to that stated on the appliance.
- Only use the appliance for domestic purposes and household or similar applications such as:
 - staff kitchen areas, in shops, offices and other working environments;
 - By clients in hotels, motels and other residential type environments;
 - Environment type like :
 - Farm Houses • Bed and Breakfast.
- Only use the appliance in the way indicated in these instructions.
- Never use this unit near bathtub, shower, wash-hand basins or other containers with water.
- Never use this apparatus near water projections.
- Never use this apparatus with the wet hands.
- If, unfortunately the apparatus is wet, immediately withdraw the cord of the socket-outlet.
- Inform potential users of these instructions.
- Never leave the appliance unsupervised when in use.
- The appliance must be used only for its intended purpose. No responsibility can be taken for any possible damage caused by incorrect use or improper handling.
- Children and persons with disabilities are not always aware of the danger posed by the use of appliances.
- This appliance shall not be used by children from 0 year to 8 years. This appliance can be used by children aged from 8 years and above if they are continuously supervised. This appliance can be used by people with reduced physical,

sensory or mental capabilities or lack of experience and knowledge if they have been given supervision or instruction concerning use of the appliance in a safe way and understand the hazards involved. Keep the appliance and its cord out of reach of children aged less than 8 years. Cleaning and user maintenance shall not be made by children.

- Cooking appliances should be positioned in a stable situation with the handles (if any) positioned to avoid spillage of the hot liquids.
- This device is not a toy, do not leave children or people with disabilities to play with.
- In order to ensure your children's safety, please keep all packaging (plastic bags, boxes, polystyrene etc.) out of their reach.
- Caution ! Do not allow small children to play with the foil :
THERE IS A DANGER OF SUFFOCATION !
- From time to time check the cord for damages. Never use the appliance if cord or appliance shows any signs of damage.
- Never immerse the appliance in water or any other liquid for any reason whatsoever.
- Never place it into the dishwasher.
- Never use the appliance near hot surfaces.
- Do not operate the appliance with a damaged cord or plug, or after the appliance has been damaged in any manner.
- If the supply cord or appliance is damaged, it must be replaced by the manufacturer or its service agent or a similarly qualified person in order to avoid a hazard.
- Disconnect the power source cable before any operation of cleaning of maintenance and accessories assembly.
- Never use the appliance outside and always place it in a dry environment.

- ❑ Never use accessories, which are not recommended by the producer. They could constitute a danger to the user and risk to damage the appliance.
- ❑ Never use any other connector than the one provided.
- ❑ Never move the appliance by pulling the cord. Make sure the cord cannot get caught in any way.
- ❑ Never wind the cord around the appliance and do not bend it
- ❑ Ensure that the power cord does not come into contact with hot parts of this unit.
- ❑ Make sure the appliance has cooled down before cleaning and storing it.
- ❑ The temperature of accessible surfaces may be very high when the appliance is operating. Never touch these parts, of apparatus, to avoid burning itself.
- ❑ Make sure the appliance never comes into contact with flammable materials, such as curtains, cloth, etc...& the power cord and plug do not come in contact with water.
- ❑ Before cleaning, always unplug the appliance from the power supply and let it cool down.
- ❑ This appliance is not intended to be operated by means of an external timer or separate remote-control system.
- ❑ Always place the unit on a flat surface. Ensure, also, not to cover the device and not to put anything on it.
- ❑ Always remove the plug from the wall socket when the appliance is not in use.
- ❑ When using an extension lead always make sure that the entire cable is unwound from the reel. Use solely CE approved extension leads. Input power must be at least 16A, 250V, 3000W.
- ❑ Incorrect operation and improper use can damage the appliance and cause injury to the user.
- ❑ This device, designed for home use, complies with standards relating to this type of product.

- The appliance must be used and rested on a table or flat & stable surface.
- The item must not be left unattended when it is connected to main supply.
- The item is not to be used, if it has been dropped or if there are visible signs of damage or if it is leaking.
- Regarding the instructions for cleaning, thanks to refer to the below paragraph of the manual.
- This appliance is only intended for household use.
- The connector must be removed before the appliance is cleaned and the appliance inlet must be dried before the appliance is used again.

(*) **Competent qualified person:** after sales department of the producer or importer or any person who is qualified, approved and competent to perform this

GENERAL INFORMATION

The symbol "OPEN BOOK" means a recommendation to read important things contained in the record.

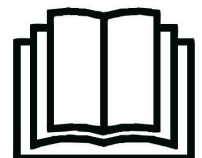

The symbol "BIN" crossed out, abbreviation WEEE (Waste of Electrical and Electronic Equipment) means that at the end of life, it should not be discarded with household waste, but filed to the sorting of the locality. Waste recovery can help preserve our environment.



The symbol "CE" is the guarantee of compliance with harmonized European standards, voluntary, reflecting the essential requirements into technical specifications. These standards are not mandatory



but are guarantees of compliance with essential requirements.

The symbol ROHS (Restriction of use of some Hazardous Substances) on the Environmental Protection, certifies that for each of the five hazardous substances • Lead • Mercury • (hexavalent) chromium • products for protection against flames PBB and PBDE, the peak concentration is equal to or less than 0.1% of the weight of homogeneous material, and 0.01% for the 6th • cadmium.



The symbol "HOT SURFACE" warns that the surface are liable to get hot during use.

The symbol "STEAM" warns the user that steam can escape from the unit and to take all necessary precautions. (Risk of burns)

The symbol "GLASS / FORK" means that the device is compatible and can come into contact with foodstuffs.

The symbol "TRIMAN" indicates that the consumer is invited to dispose the product as part of a separate collection (eg recycling bin, waste, voluntary intake point).

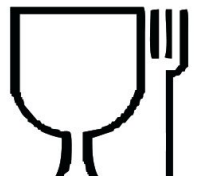
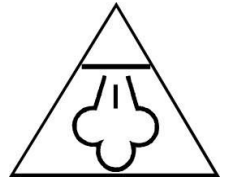

For more information : <http://www.quefairedemesdechets.fr>

TO KNOW YOUR APPLIANCE

Unit overview:

- 1 Glass cover handle
- 2 Power connection base
- 3 Basic unit
- 4 Handles
- 5 Cooking surface
- 6 Glass cover

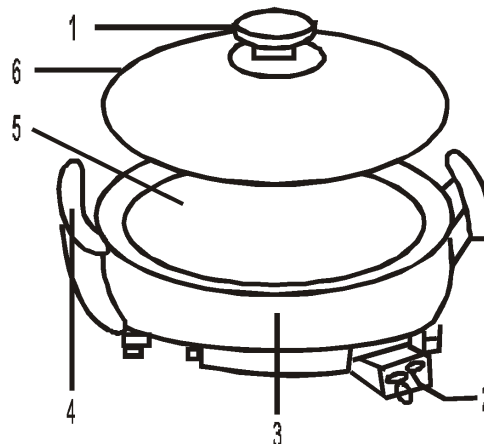

Temperature sensor:

- 1 Temperature sensor
- 2 Electric plug
- 3 Electric cable
- 4 Temperature regulator
- 5 Control lamp

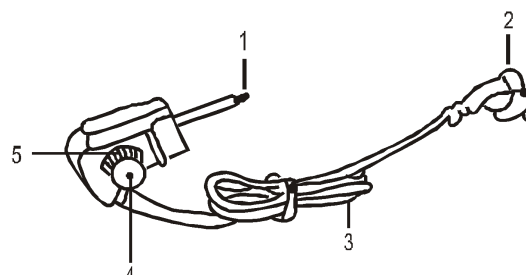

FIRST USE

- Before first use, remove the unit and all accessories carefully.
- Clean the apparatus according to the instructions in "Cleaning" paragraph.
- Place the machine on a suitable flat, stable surface.

USE

- Unroll the power cord completely.
- Check that the tension in force in the country where you are corresponds to that indicated on the apparatus.
- Connect the apparatus in a correct socket-outlet, (and connected to the ground if the unit is Class I), to avoid any danger.
- Disconnect the power source cable before any operation of cleaning of maintenance and accessories assembly.
- Never modify the appliance in anyway.

Preparing the unit

NOTE : The surface of this device will remain in good condition for a long time if you take some precautions :

- a) Do not use metal objects such as knife, fork, etc.. This could damage the unit.
- b) Use only plastic utensils (heat resistant) to stir or remove ingredients.
- c) Clean the unit only with a soft sponge and washing liquid or use the dishwasher.

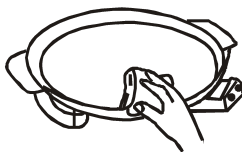

1. Connecting the unit:

1. Connect the temperature regulator to the base of the basic unit.
(Make sure that the plug is connected properly.)

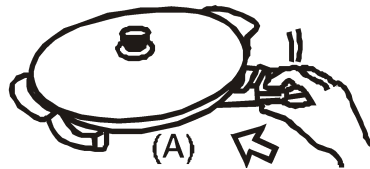

- 2 Set the temperature selector switch to heat level "0".
- 3 Connect the apparatus in a correct socket-outlet, (and connected to the ground if the unit is Class I), to avoid any danger.



ATTENTION:

Do not use a multiple outlet strip or extension cable.

Preparing foods:

1. Brush the pan with a little cooking oil.
2. Set the temperature regulator to the required heat level.

The control lamp will light up to signal that the unit is ready for use (ON).

NOTE : It takes ca. 5-10 minutes after the unit is switched on before the control lamp goes out. You can then start cooking the food.

Once cooking is complete, the unit can be kept warm. To do this, set the temperature regulator to the thermostat level.

Using the cover:

Use the glass cover where possible when cooking all food types.

The cover prevents smells from escaping and reduces cooking time.

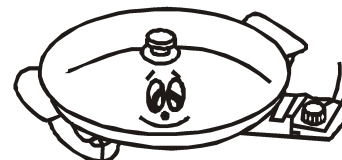

Note The glass cover has a vent through which hot steam can escape! Avoid contact with this escaping steam.

The cover can become extremely hot during operation therefore use oven gloves, etc. where possible when removing the cover to avoid burns.

Heating levels	Temperature C°	Food type
1 & 2	ca. 100 C°	Roasted food, meat, etc.
3 & 4	ca. 150- 200C°	Pancakes, scrambled eggs, bacon, etc.
5	ca. 240 C°	Grilled foods, pizza, etc.
Thermostat		Warming function

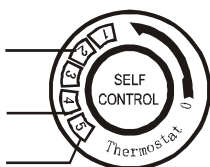

After use:

Set the temperature regulator to the 0 level
 Pull the plug out of the mains socket!
 Allow the unit to cool down thoroughly before cleaning it.

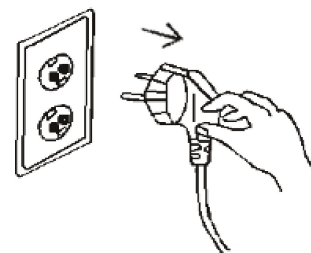

CLEANING AND MAINTENANCE

Before cleaning, Always : switch off the appliance, disconnect the apparatus and let it cool.

Clean the outside of the apparatus with a sponge or slightly wet linen.
 The parts (removable) in contact with food like plate, bowl, forks, Spatula etc. can be washed in hot water with sponge and soft detergent or put in the dishwasher.
 Never plunge the apparatus in water or all other liquid !
 Do not use abrasive cleaners, gritting, or metal brush or another cutting object.

Cautious measures to be operate the heat plate

The surface of the heat plate is antiglare, so take care as following:

Do not use sharp shovel made of metal. (If the beefsteak should be cut, put the good on another plate then cut.)
 Do not use a sharp knife to cut the good on the surface.

Do not put the automatic Temperature regulator on the heat plate.

It is not permitted to contact with the heat plate.

Do not use cleaner, nylon brush or metal brush, The surface of the heat plate would be damaged.

The plate must be cleaned after using with a wet cloth. Good rest or fit on the surface would lead to fire

STORAGE

-Ensure the unit is completely cool and dry.

-Do not wrap the cord around the appliance, as this will cause damage.

-Keep the appliance in a cool, dry place and out of reach from children.

GUARANTEE

Before being delivered, all our products are subjected to a rigorous control.

This apparatus is guaranteed 24 months starting from the date of purchase by the consumer.

The documents in proof of guarantee are :

- The invoice and
- The filled and stamped warranty plate (located on side or bottom of the gift box). Without these documents in proof, no free replacement, nor no free repair, can be carried out.

During the warranty period, we deal for free, the defects of the apparatus or the accessories, rising from a defect of materials or manufacture by repair or, replacement. The services within the framework of the guarantee do not involve any extension of the warranty period and does not give right to a new guarantee ! In the event of recourse to the guarantee, bring back the complete apparatus to your retailer, in its original packing, accompanied by the proofs of purchase.

The breakage of parts out of glass or plastic is, in all the cases, not warranted.

Defects on the accessories or the wearing parts (for example: coals of engines, hooks, drive belts, remote control of replacement, teeth brushes of replacement, webs etc) as well as cleaning, maintenance or it replacement of wearing parts are not guaranteed and are thus to pay !

In the event of foreign intervention, the guarantee becomes null and void.

After flow of the warranty period, repairs can be carried out, against payment, by a specialized trade or a repair service.

SPECIFICATIONS

Power supply	220-240V~ 50-60Hz
Power	1500W
Size TP-3034	30cm and depth 4,3cm
Size TP-3842	38cm and depth 4,3cm
Norm	Class I

Made in P.R.C

The characteristics can change without preliminary preventing

This device complies with EC directives, it was controlled according to all current European directives, applicable such as: electromagnetic compatibility (EMC) and low voltage (LVD).

This device has been designed and manufactured in compliance with the latest regulations and technical requirements for safety.

This unit is equipped with an electrical outlet with earth and must be earthed in an according plug.

Note : In the event of question concerning the earth or electric connection, please consult a qualified personnel.

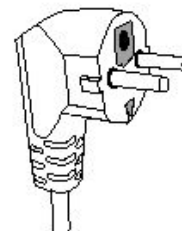

In the event of short-circuit, earthing reduces the risk of electric shock while making possible the current to be evacuated by the wire of ground.

CAUTION: In order to minimize the risks of electric shock, In the event of breakdown, not to open the case but to call upon a qualified technician for repairs.

**Imported by Sotech International
" LE PERIPOLE " N°A107
33, Avenue du Marechal de Lattre de Tassigny
94120 Fontenay sous bois – France
Made in P.R.C**